



INNOVATION DRIVES YOU FORWARD



Chassis - Bodywork - Accessories

Operation and maintenance manual





INNOVATION DRIVES YOU FORWARD

Contents

ENGLISH

Contents	1
Introduction.....	6
Safety	
1) To be checked before each journey:	7
2) Always keep the following documents in the vehicle:.....	7
.....	8
Identification	9
Tractor compatibility	10
1) Coupling device	10
2) Dimensions	10
3) Electrical installations	11
4) Brake system	12
Use 13	
1) Before driving	13
2) Loading and unloading	13
3) Important driving rule	13
4) Uncoupling	13
5) Coupling procedure	14
Technical specifications	15
1) Frame structure	15
2) Multi-axle bogie.....	16
3) Wheels and tyres	17
4) Suspension.....	19
5) Brake system: general information	21
6) Electronic Brake System: EBS	24
7) Coupling.....	31
8) Electrical installations	32
9) Landing gear	33
10) Odometer.....	33
11) Lashing rings.....	33
12) Rear underride protection bar	33
13) CHEREAU refrigeration unit fuel tank	34
14) Rear protection	34
15) Rear Detect-C.....	35
Servicing and maintenance operations	37
1) General information	37



INNOVATION DRIVES YOU FORWARD

2) Washing.....	37
3) Multi-axle bogie.....	37
4) Brakes and suspension	38
5) Lights and signalling.....	39
6) Coupling.....	41
7) Wheels and tyres	41
8) Rear protection.....	41
9) Fuel tank.....	42
10) Landing gear.....	42
11) Accessories fixed under the bodywork	42
APPENDIX I: Electrical adapters.....	43
APPENDIX II: Electrical wiring.....	44
APPENDIX III: Wheels and tyres	48
1) Speed indicators	48
2) Load indicators	48
APPENDIX IV: Torque parameters	49
.....	52
Introduction.....	53
Identification	54
Cleaning.....	55
Use 56	
1) Temperature inside the body	56
1) Rear doors:	56
2) Loading: general rules	56
3) Using the auxiliary equipment.....	58
4) Lashing the cargo.....	58
5) Closing the doors.....	58
6) Cargo temperature	58
Isothermal chamber.....	59
1) Structure.....	59
1) Thermal efficiency	59
2) Coatings and protection	60
3) Openings.....	60
4) Repair and maintenance.....	61
Internal equipment.....	62
1) Bulkheads	62
2) Meat hanging systems.....	66
3) Lashing rails	67
4) Self-tightening grids.....	68



INNOVATION DRIVES YOU FORWARD

5) Intermediate flooring	69
6) Multideck-C	71
7) Roller curtains.....	79
8) Air Shutter-C.....	79
9) Internal suspension control.....	81
Refrigeration unit	82
Safety equipment	84
1) Splash and spray guards	84
1) Side guards	84
2) Rear underride bar	85
Lights and signalling.....	86
T.I.R. Equipment	88
Auxiliary equipment	90
1) Tailgate lift.....	90
2) LEVIAND.....	91
3) Pallet holder	92
4) Wheel holder	92
5) Toolbox.....	93
6) Stepladder and ladder	93
7) Fire extinguisher	93
8) Central greasing.....	93
9) Rear protection.....	94
ATP Regulations.....	95
1) Definition	95
2) Marking	95
3) Documents	95
Noise reduction	96
1) Handling bulkheads	96
2) Handling tail-lifts	97
3) Handling steps	98
4) Handling doors	99
Servicing	100
1) General	100
2) Body and internal equipment.....	100
3) Refrigeration unit	101
4) Auxiliary equipment and lighting.....	101
5) Multideck-C equipment.....	102
Introduction.....	104



INNOVATION DRIVES YOU FORWARD

Identification	105
Safety 106	
1) To be checked before each journey:	106
2) Always keep the following documents in the vehicle:.....	106
Cleaning.....	107
Use 108	
6) Temperature inside the body	108
1) Rear doors:	108
2) Loading: general rules	108
3) Using the auxiliary equipment.....	110
4) Lashing the cargo.....	110
5) Closing the doors	110
6) Cargo temperature	110
Isothermal chamber.....	111
1) Structure.....	111
2) Thermal efficiency	111
3) Coatings and protection	112
4) Openings.....	112
5) Repair and maintenance.....	113
Internal equipment.....	114
1) Bulkheads	114
2) Meat hanging systems.....	118
3) Lashing rails	119
4) Self-tightening grids.....	120
5) Intermediate flooring	121
6) Multideck-C	123
7) Roller curtains.....	131
8) AirShutter-C.....	131
9) Internal suspension control.....	133
Refrigeration unit	134
Safety equipment	136
1) Splash and spray guards	136
2) Side guards	136
3) Rear underride bar	137
Lights and signalling.....	138
T.I.R. Equipment	140
Auxiliary equipment	142
1) Tailgate lift.....	142



INNOVATION DRIVES YOU FORWARD

2) LEVIAND.....	143
3) Pallet holder	144
4) Wheel holder	144
5) Toolbox.....	145
6) Stepladder and ladder	145
7) Fire extinguisher	145
8) Central greasing.....	145
9) Rear protection.....	146
ATP Regulations.....	147
1) Definition	147
2) Marking	147
3) Documents	147
Noise reduction	148
1) Handling bulkheads	148
2) Handling tail-lifts	149
3) Handling steps	150
4) Handling doors	151
Servicing	152
1) General.....	152
2) Body and internal equipment.....	152
3) Refrigeration unit	153
4) Auxiliary equipment and lighting.....	153
5) MultiDeck-C equipment	154
6) Aerodynamic accessories	155
APPENDIX: Torque parameters	156



INNOVATION DRIVES YOU FORWARD

Introduction

- ◆ This manual is designed to help you operate and maintain your CHEREAU vehicle. It should always be kept in your vehicle and read by all users of the vehicle and maintenance staff.

☞ **Please note that CHEREAU vehicles are designed to be used by freight professionals who in turn, have the responsibility to ensure that the vehicle is used in compliance with current local regulations.**

- ◆ The vehicles and equipment described in this manual have been designed to be compliant with CHEREAU's requirements. **It is prohibited to modify in any way either the structural or safety features of the vehicle.** Written authorisation of CHEREAU must be obtained prior to any such action.
- ◆ In order to ensure the safety of the vehicle user, the vehicle must be kept in good working order. All maintenance work and checks must be carried out according to the present instructions.
- ◆ CHEREAU reserves the right to make any alterations deemed necessary for improving its products, on its entire product range, without prior notice.
- ◆ For further information please contact your local CHEREAU agent. A full list of our agents and their contact details is available on the web site:

www.chereau.com

Safety

1) To be checked before each journey:

- ◆ That all back and side doors are closed.
- ◆ That the back doors are properly locked and that steps and ladders are correctly secured.
- ◆ That all lights are working properly.
- ◆ That the level of fuel, engine oil and cooling liquid of the refrigeration unit is sufficient.
- ◆ Prior to the use and maintenance of carrier vehicles, it is essential that the safety instructions of the chassis manufacturer are known and followed.

2) Always keep the following documents in the vehicle:

- ◆ Registration Document
- ◆ Certification of conformity to the ATP - chassis user manual
- ◆ Operation and Servicing manual for the body
- ◆ User's Manual for the refrigeration unit.
- ◆ User's Manual for all auxiliary equipment (tailgate, Leviand...)
- ◆ T.I.R Certificate (optional)



INNOVATION DRIVES YOU FORWARD



CHASSIS

Identification

- ◆ All CHEREAU vehicles can be identified by their manufacturer's plate situated on the right side beam, near the landing gear. The vehicle's serial number is stamped both on the manufacturer's plate and on the side beam next to it.

The vehicle identification number must be quoted in all correspondence.

- ◆ Decoding the serial number:

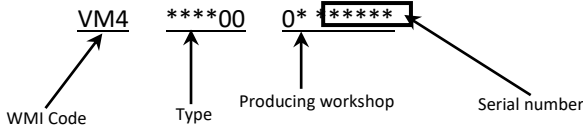

- ◆ Information indicated on the manufacturer's plate:

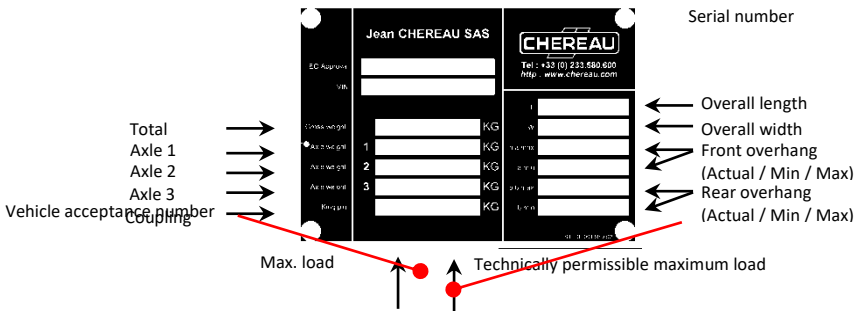

Tractor compatibility

- ◆ Before coupling, check whether the tractor is compatible with the vehicle to be towed, according to the instructions in this chapter.

1) Coupling device

Semi-trailer

- ◆ The height of the fifth wheel must be such to ensure that once coupled, the front part of the semi-trailer is higher than the rear, the angle not exceeding 1% (1

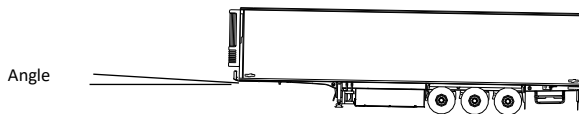

centimetre per meter).

- ◆ Verify that the fifth wheel and the turntable are compatible (example: ISO Ø50) and that the fifth wheel is in good condition.

Trailer

- ◆ Verify that the coupling ring and hook are compatible (model and diameter).
- ◆ Check that the distance between the rear of the tractor and the front of the trailer is sufficient to allow the necessary manoeuvres without risk of collision.
- ◆ Once the trailer is coupled, check that the beam or the drawbar is in a horizontal position.
- ◆ Once coupled, check that the centre axle trailer is in a horizontal position.

2) Dimensions

- ◆ Once the coupling operation has been completed, check that the overall train length is compliant with current regulations.

3) Electrical installations

- ◆ Check that electrical connectors are compatible: plug in and test all lights
- ◆ If the vehicle connectors are different, it may be possible to use an adapter (see page **Erreur ! Signet non défini.**).

Typical connections on a standard socket

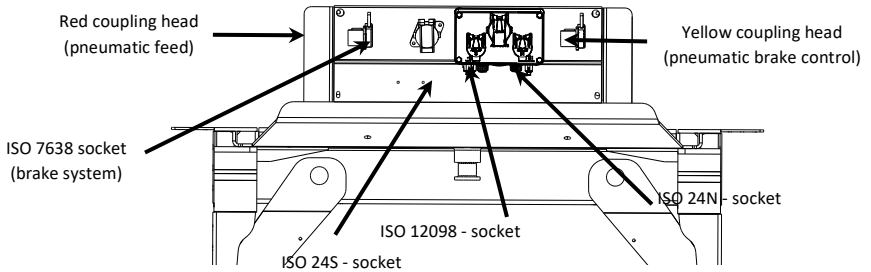

- ◆ On CHEREAU vehicles fitted with Flex-C LED M758 lights or with round LED M810 lights, it is fitted in the TMU box that allows trailers to:
 - detect the presence of the semi-trailer in spite of the low current consumption of the LEDs (where the tractor's electronics do not).
 - _to detect any failure of rear LED flasher and stop-light functions.

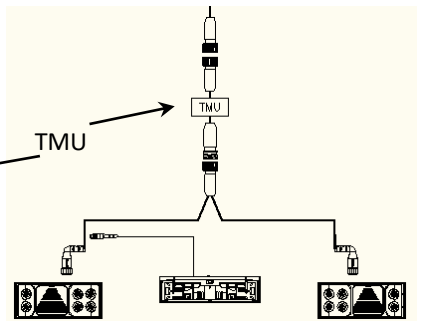

- ☞ **The TMU box does not signal the failure of the other rear lights to the tractor: position, fog or reversing.**
- ☞ **Despite of the presence of this box, some tractor units will display a fault on the dashboard due to the semi-trailer being fitted with LED lights. If this is the case, contact your dealer.**

4) Brake system

- ◆ Brake system connections comprise three sockets:
 - Yellow pneumatic coupling head
 - Red pneumatic coupling head
 - EBS (electric) or ISO7639 socket

 **It is forbidden to drive if any of the above three sockets is not properly connected.**

- ◆ In all cases, the tractor unit must be equipped with a socket meeting the requirements of ISO standard 7638 (“ABS”), in a serviceable condition (for further information, see page **Erreur ! Signet non défini.**).
- ◆ The brakes on the tractor and semi-trailer must be adjusted to ensure even distribution of the braking effort, uniform wearing of friction linings and good road handling. This adjustment must be made using a brake-testing machine.
- ◆ In order to optimise braking conditions, it is advised that semi-trailers equipped with disk brakes should only be towed using tractors with disk brakes.

Use

1) Before driving

- ◆ Check that the wheel nuts are properly tightened (see page 16).
- ◆ Ensure that the dump valve lever is in the 'run' position.
- ◆ Check that the brake system and all lights are working properly.

2) Loading and unloading

- ◆ Only coupled vehicles may be loaded or unloaded.

 **Only lifting devices with a maximum load of up to 5 tons can enter the body.**

- ◆ Ensure that neither the maximum load nor maximum authorised load per axle is exceeded (see the manufacturer's plate and regulatory documentation).
- ◆ Ensure that the load is equally distributed over the length and width of the vehicle.
- ◆ Secure the load to avoid dislodging during transportation.

3) Important driving rule

- ◆ Please remember that the overheating of the disk brakes, although not detectable whilst driving, can have serious consequences and may even completely destroy the brakes.
- ◆ Consequently, particular attention should be paid to the temperature of the brakes during long descents and, if necessary, stops should be made.

4) Uncoupling

 **Do not raise the tractor unit suspension before uncoupling the trailer**

- ◆ Uncoupling must be done in a flat horizontal area. For vehicles with a steering rear axle, it must be done with the axle set to the straight line position.
- ◆ Apply the semi-trailer's parking brake and chock the wheels.
- ◆ Lower the landing gear.
- ◆ Disconnect the electrical and pneumatic circuits.
- ◆ Release the coupling system.
- ◆ Slowly uncouple the vehicle from the trailer or body.
Note: where applicable, do not forget to lower and lock the tractor's underride device after this operation.

5) Coupling procedure

- ◆ Ensure that the parking brake is engaged.
- ◆ Inspect the state of the coupling elements.
- ◆ For vehicles with a steering rear axle, check that it is in a straight line and carry out the coupling operation in a straight line.
- ◆ Reversing in alignment with the semi-trailer, move the tractor until the coupling system locks (when coupling a centre-axle trailer remember to extend the anti-underride bumper on the tractor).
- ◆ Test the traction.
- ◆ Visually inspect the system to check that it has been locked correctly.
- ◆ Raise the landing gear.
- ◆ Connect all air lines and electric cables.
- ◆ Disengage the semi-trailer's parking brake.

Technical specifications

1) Frame structure

- ◆ The frame consists of longitudinal and transverse beams on which all the technical equipment of the vehicle is mounted. Various components are either welded or bolted onto the frame.
- ◆ This steel structure benefits from an anti-corrosion treatment and "offshore" quality finish coat paint.

Alteration and work

✉ **Authorisation from CHEREAU must be obtained prior to undertaking any work on the frame which may change its technical specifications. Please contact CHEREAU SERVICES for all such permission requests.**

- ◆ When carrying out work involving welding on the frame, it is important to protect all electric circuitry and air lines as well as all electrical and pneumatic installations. Do not connect the earth to the wheel nuts as this may interfere with the rolling movement.

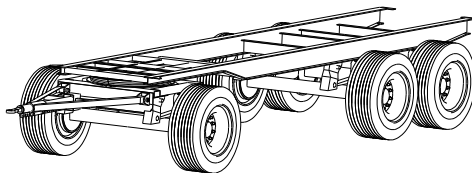
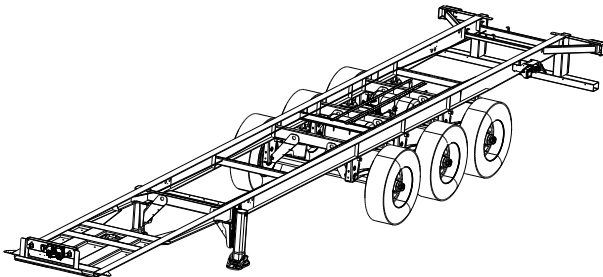

2) Multi-axle bogie

- ◆ Each axle is identified by a plate displaying at least the following information:
 - Axle make.
 - Type.
 - Serial number.
 - Test report reference number.
 - Maximum static mass for the axle.
 - Maximum authorised speed limit.
- ◆ The operation and maintenance manual containing information about axles is included in the vehicle's technical documentation. Please consult this manual for all information regarding axle use and maintenance.

☞ **If one of the axles needs replacing it may only be replaced with an axle of the same technical specifications.**

Self-steering option

- ◆ The self-steering axle is an optional piece of equipment which limits shifting of the axle in bends.
- ◆ For manoeuvres involving reversing, the self-steering axle should be locked in the following way:
 - Advance a few meters in a straight line to align all axles
 - Press the command button (or, where necessary, otherwise activate the electronic command system).
- ◆ Do not forget to unlock the self-steering axle before driving off.

☞ **It is prohibited to drive with the self-steering axle in the locked position.**

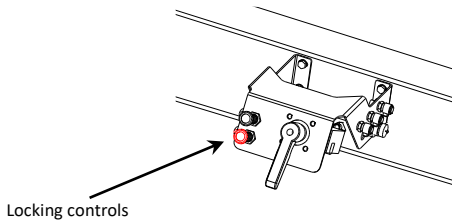

3) Wheels and tyres

 **Never deflate a warm tyre.**

- ◆ Observe the pressure parameters as advised by the tyre manufacturer. Underinflated tyres contribute to heating of the tyre and may lead to damage on the internal parts of the tyre or even to its destruction.
- ◆ Never carry out any repair work on the rims by welding.

Identification

- ◆ Tyre details are displayed on its casing. They are engraved in three lines. The brand and type are on the first line with technical specifications on the second and third lines.
- ◆ Example of technical data marking:

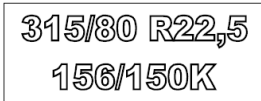

315/80 R22,5
156/150K

- ◆
 - 315 Indicates the width of the tyre
 - 80 Nominal height or side aspect ratio
 - R Radial structure
 - 22.5 Rim diameter
 - 156 Max. load with single tyres
 - 150 Max. load with double tyres
 - K Speed parameter.

Normal values for the above variables are indicated in the annex on page 48.

Wheel mounting

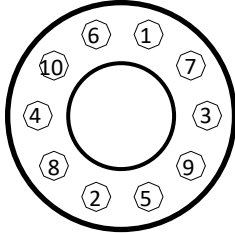
- ◆ Position the wheel ensuring good alignment and valve position. All contact surfaces should be perfectly clean and should not be painted.
- ◆ Loosely tighten the bolts in the following order:



10 hole hubs

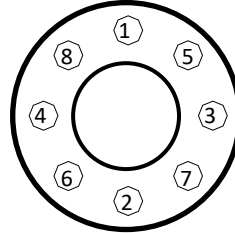

8 hole hubs

- ◆ Tighten nuts using a torque wrench in the same order as above, using the tightening torque indicated in the axle servicing manual. The use of an impact wrench is only permitted for loosening.

 **Recommendations for torque.**

Maintenance and works

- ◆ Only replace tyres with those of identical dimensions and specifications.
- ◆ When mounting double tyres, they must be of the same dimension, make, model, shape, degree of wear and pressure.

 **After the tyres have been mounted, the tightness of the bolts should be rechecked after 50 km.**

4) Suspension

Bogies are equipped with air suspension which consists of air cushions fed by a pneumatic circuit as described in this chapter.

Suspension system

- ◆ The suspension system consists of one float valve, one dump valve and, optionally, one axle-lifting valve.
- ◆ The air supply for the suspension system is maintained by the means of a shut-down valve. The calibration of this valve should not be modified.
- ◆ The height of the vehicle is maintained, regardless of the load, by the float valve which keeps a constant pressure inside the suspension cushions. This function can only be performed when the dump valve is in the “run” position.

Raising and lowering function

☞ To use the raise and lower function, the vehicle must be hitched, brakes applied and the leg stand raised.

- ◆ The dump valve is used to set the vehicle height during docking (the vehicle is coupled). The valve control is situated at the back of the frame.

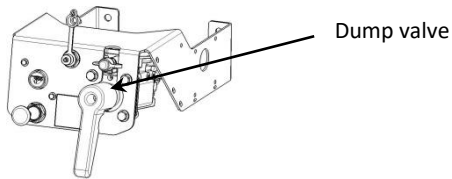

To set the height:

- Press to release the control handle.
 - Turn the handle in order to raise or lower the vehicle.
 - Once the desired height is reached, put the handle in the “stop” position.
 - ◆ To return to ‘run’ mode:
 - Pull the lever to set it in the ride height.
- ☞ We recommend returning the dump valve to the ‘run’ position before driving.**
- ◆ The raise and dump valve with automatic return to the “run” position is standard equipment. In the event that it is not returned to the run position, a function reinitialises it is “run” position, as soon as the speed reaches 10 k.p.h. This function operates on electrical information from the EBS system.

Axle lifting

- ◆ The axle lifting mechanism is optional
- ◆ This piece of equipment allows the driver to lift an axle when driving empty or when the vehicle is only partly loaded. The controls for this mechanism are situated on the left, at the back of the vehicle. When engaged, lifting occurs automatically and as soon as contact is cut, the raised axle lowers.
- ◆ Operation is automatic: the axle is automatically lowered as soon as the maximum load on the axles is reached. The axle is automatically lifted as soon as the load is sufficiently reduced.

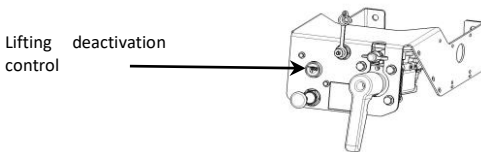

- ◆ To force a lifting axle to lower, maintain pressure on the control button at the left rear of the vehicle for 5 seconds.
- ◆ As an option, raising a lift axle can be electrically controlled from the tractor unit by pressing a button (contact our technical department for details of the electrical interface).
 - Press > 5 secs: the raising function is deactivated (the axle is down),
 - Press < 5 secs: the raising and pull-away assistance function, within the axle loading limits and the 18 mph speed limit, are active (the axle is raised).

Maintenance and repairs

- ◆ In case of impossibility to inflate the air suspension, please reach the nearest workshop at 12 mph maximum speed

5) Brake system: general information

- ◆ The vehicle brake system uses various electric and/or air components. The exact configuration of these components may vary depending on the options with which the vehicle is equipped.
 - ◆ Braking is managed electro-pneumatically through the EBS (see page 22).
 - ◆ The red coupling head supplies air to the brake chambers. The yellow coupling head transmits pneumatic control signals to the brake system.
 - ◆ Electric feed for **the brake system is maintained through the “ABS” socket (ISO 7638).**
-  **Please observe the parameters pertaining to compatibility between the brake systems of the tractor and the towed vehicle (page 11).**

Parking brake

- ◆ All vehicles are equipped with a spring-type parking brake. The controls are situated either by the landing gear or at the back of the vehicle.
-  **The parking brake must be used whenever the vehicle is not coupled.**

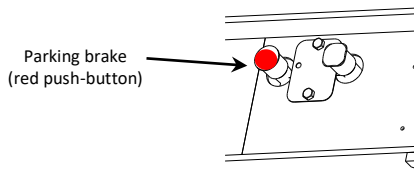

- ◆ To apply the parking brake: pull the red button. Optionally, the parking brake may be applied automatically if the coupling head is disconnected.
- ◆ To release the parking brake, push in the red button and keep pushed for a few seconds.
- ◆ Do not forget to release the parking brake before driving.
- ◆ Releasing the parking brake may cause the vehicle to move.

Emergency brake

- ◆ If the red coupling head becomes disconnected or ruptured the brakes are engaged automatically by the safety mechanism (emergency brake).
- ◆ The air brake operates from air reservoirs or spring cylinders

☞ The emergency brake should therefore, not be used to immobilise a parked vehicle.

- ◆ To move an uncoupled vehicle: The commands necessary for this operation are situated either by the landing gear or at the back of the vehicle.
 - Press the black button to release the brakes.
 - Pull out the red button to release the parking brake.
 - Carry out the manoeuvre.
 - Pull out the red button to engage the parking brake.(The control is situated either close to the landing gear or at the rear of the vehicle).

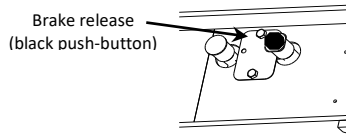

Maintenance and repair

- ◆ The brake system must be maintained in good working order through application of the guidelines on page 37.

☞ All work on the brake system must be carried out by qualified, skilled professionals.

- ◆ Only components matching the specifications of those being replaced may be used. Check the information provided on the reference plate of the faulty part.
- ◆ Air line tubes are standardised; the reference, the original length and diameters must be observed.
- ◆ In some cases it may not be possible to release the parking brake due to a significant pressure drop. In such instances, and for the purpose of removing the vehicle from the road only, the parking brake may be released in the following way:
 - Locate the screw situated on the side of the spring chamber.
 - Turn the screw until it reaches the notch at the back of the chamber.
 - Turn the nut to compress the spring.

Or:

- Remove the nut locking device at the back of the chamber.
- Turn the nut to compress the spring.

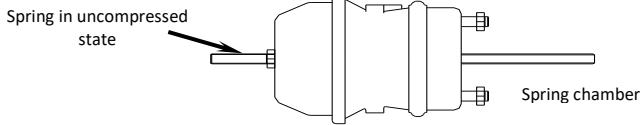

☞ It is strictly forbidden to drive if the brake is disengaged in this way.

6) Electronic Brake System: EBS

- ◆ The electronic brake system consists of an Electronic Control Unit (ECU) linked to pressure and wheel speed sensors. Depending on the sensor signals, the ECU adjusts the braking pressure using the corresponding solenoids.
- ◆ The command to brake is transmitted either electronically (through the 7-pin ISO 7638 socket) if the tractor is equipped with electronic brake controls, or pneumatically, (sent through the yellow coupler) where the tractor has a conventional brake system (5-pin ISO 7638 socket).

 **Never drive with the ISO 7638 socket disconnected (socket or “EBS”).**

Electronic Control Unit ECU

- ◆ The ECU performs both the pressure adjustment and anti-lock functions. It adjusts the pressure in the brake chambers, depending on both the load carried by the vehicle and the degree of contact with the road.
- ◆ The ECU also manages the options of return to ride height position, roll stability system, axle raising, brake pad wear indicator, smartboard display and ECAS suspension system in the case of an articulated truck.
- ◆ The setup values for the correction function are marked on the EBS plate which, by default, is located on the right hand chassis beam. This plate also shows the chassis number, the type, the braking approval number, the braking computing number and the various configured options.

Functions of the Electronic Control Unit ECU

- ◆ By default, the ECU has 2 operational modes:
 - **Electric brake control** for tractors equipped with an electronic brake system and a 7-pin ISO 7638 socket (EBS tractors).
 - **Air brake control** for tractors equipped with a conventional brake system and a 5-pin ISO 7638 socket (ABS tractors).
- ◆ In case of power failure the ECU switches to the **backup mode** (note that in this mode, the anti-lock and adjustment functions are no longer available). In such cases, the light indicator will signal a malfunction. If this happens the vehicle should be immediately stopped and an authorised service centre contacted.

Malfunction signals are described in the table below. For more detailed information regarding various EBS- related indicators in the tractor, please see the vehicle’s technical documentation before driving.

Light indicator signals:

Scale of malfunction	Indication	Repair
Minor	Yellow indicator: Temporary or flashing	The fault can be corrected at the next service
Average	Yellow indicator: On steady	The fault should be corrected ASAP
Serious	Red	Stop immediately

Repair and maintenance

- ◆ Works on the EBS system may only be carried out by qualified, skilled professionals.
- ◆ The ECU calibration data may be obtained either from the EBS plate or by contacting CHEREAU SERVICES.

Digital display

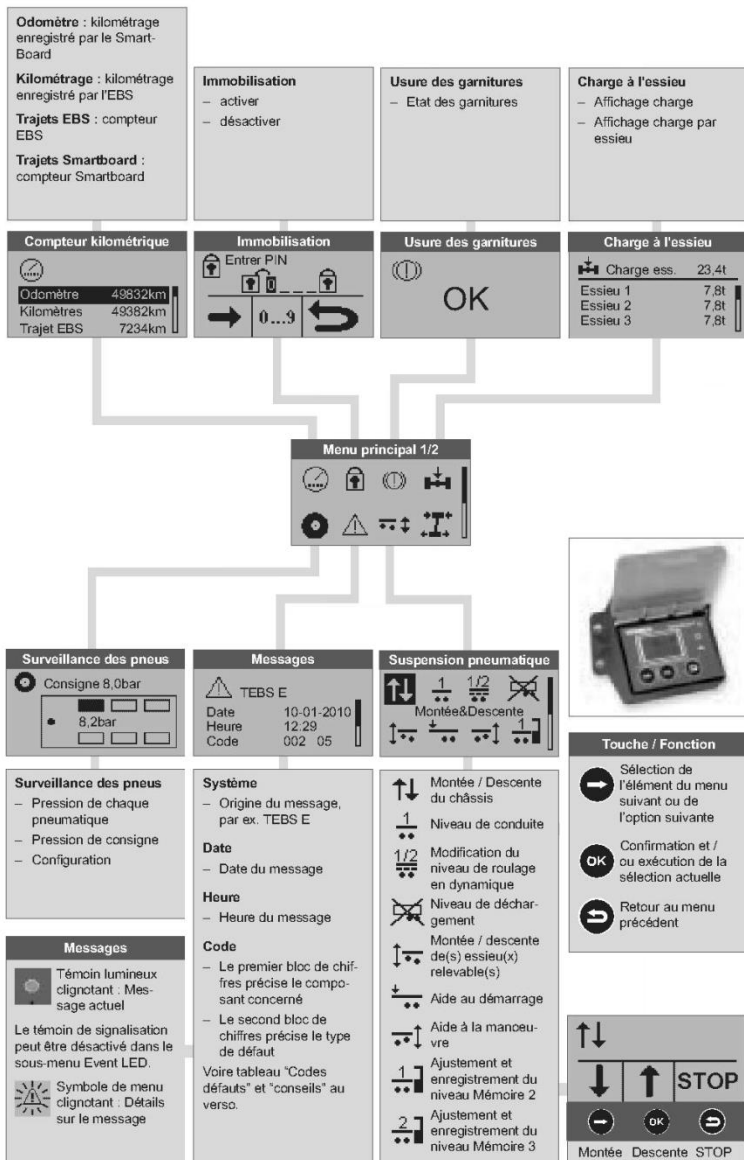



Risque de blessure en cas de roulage du véhicule

- Veuillez respecter toutes les consignes de sécurité
- Veuillez vous assurer que personne ne se trouve dans la zone à risques pendant l'activation des fonctions du système

Desserrage frein



Desserrage frein
"OK" pour desserrer frein
Garde aux règles de sécurité

Menu principal 2/2



Sélection de la langue



Langue
● Français
Русский
Italiano

Extras



Extras
▶ Données TEBS
▶ Info système
▶ Paramètres

Pack A

- English
- Deutsch
- Español
- Nederlands
- Français
- Русский
- Italiano
- Türkçe
- Polski

Pack B

- English
- Deutsch
- Français
- Ελληνικά
- Česky
- Svenska
- Suomi
- Português

Données TEBS

- Affichage données remorque
- Données ODR
- Mémoire des paramètres

Info système

- Système
- IVTM
- Smart Board

Paramètres

- Unités
- Horloge
- Image splash
- Événement LED
- Pneu
- Menu de démarrage
- Charge
- Calibrer capteur
- IVTM
- Nouveau PIN

Auto-config

Info Centre 2 Quick Start Guide



Innovative Vehicle Solutions

Description

Info Centre 2 is a side of trailer mounted diagnostic unit used for readout of odometer, diagnostic codes and other information as available in the EB+ Electronic Control Unit (all current features available when the EBS is programmed and using C497/498/499 or higher level of software).

The Info Centre 2 is connected permanently to the ECU's diagnostic 'DIAG' connection. While the ECU is powered from its normal source (ISO 7638 permanent) information is transferred to the Info Centre's memory, which can be recalled. Power is supplied from the vehicle system via the ECU diagnostics connector.

An Info Centre 2 ADR version is also available which has no battery fitted and therefore cannot operate in the battery mode (i.e. no information will be available if the vehicle is not powered by the ISO 7638). Other functions which relate to the battery, (e.g. clock) are also not available when the Info Centre 2 is powered from the EB+ system.

Key Feature:

The Info Centre 2 has a Start Screen that displays Operator configurable information when the Info Centre is first powered (see Start Screen section).

This ensures that any Operator specific information is always the first to display upon powering the unit.

Front Panel Information

OK Button



This button is used to:
Switch 'ON' the info Centre Unit
Enter into sub menus
Enter/confirm info centre actions
Enter/confirm info centre value changes
Enter/confirm info centre configuration changes

UP Arrow & DOWN Arrow



This button is used to:
Switch 'ON' the info Centre Unit
Scroll up the main & sub menus
Select info centre configuration units
Select numerical numbers

Service LED



Indicates that the Info Centre is OK (only when running on its internal battery) or that the EB+ power is connected, and it is configured to show faults

Service LED Flashing 'ON' & 'OFF'



Indicates that active DTCs are present or that the service interval period has expired.

The light will flash for 10 minutes after the power is removed, or after the Info Centre 2 switches itself 'off'

Password Protection



All of the screens which allow the user to change any of the data fields are password protected.

If the user enters a function whilst the Info Centre is locked they will be prompted to enter the PIN as per the unlock function in the settings menu.

Note: As standard the Info Centre will be supplied with the PIN set to 0123.

The Info Centre PIN remains active for:

- > 1 minute in a menu
- > 2 minutes in a function

Permanent PIN Removal

To permanently remove the PIN function from the Info Centre menus, set the PIN number to be 0000. This will stay active until an alternative PIN is entered again.



Information



The **Information** menu displays data from the EBS.

DTC

Active

Displays up to 8 active DTCs

Stored

Displays up to 8 stored DTCs

Clear

Clears all DTCs from the EB+

Service Lamp

Displays the reason for the flashing trailer warning lamp

LED Flashing

Displays the reason for the flashing Info Centre service LED

Lining Wear

Lining wear

Displays the brake lining wear status (OK or service) of the trailer

LWI Reset

Used to reset the lining wear status indicator following the replacement of the brake lining.

Tyre Pressure

Tyre Pressure

The tyre pressure monitoring system constantly measures the air pressure and temperature in the trailer tires

Distance

Odometer Data

Displays the mileage that is stored in the EB+. It can be configured to display in miles or km

Trip 1 Data

Displays the mileage recorded by the EB+ since trip 1 was last reset

Trip 2 Data

Displays the mileage recorded by the EB+ since trip 2 was last reset

Service (km)

Displays the distance (Miles or km) until the next service

Service (Days)

Displays the number of days until the next service

Trailer

Load Plate

Displays the EB+ load plate info

Configuration

Shows a graphic display of the EB+ configuration.

VIN

Displays the VIN from the EB+

ECU Version

Displays the EB+ software version
Displays the EB+ serial number
Displays the Info Centre version

Fleet+ Data

The Fleet+ PC program enables the operator to view trailer information. The Info Centre extracts summary data to provide an understanding of recorded events.



Test



The **Test** menu displays data and operates some of the auxiliary functions of the EBS.

Load

Displays the current trailer load.

Tilt Angle

Displays the angle of the trailer in degrees as read from the EBS.

Air Pressure

Displays the EBS air pressures.

Wheels

Displays the current trailer wheel speeds.

Aux Test

This menu is used to switch 'ON' or 'OFF' the EB+ auxiliary functions.

Brake Test

This menu is used to switch 'ON' or 'OFF' the EB+ load sensing function.

For more detailed information refer to the "Info Centre 2 Operators Guide" (reference no. 006 300 001) available at www.haldex.com



The **Settings** menu is used to set the configuration of the Service Interval, Info Centre 2, LED Settings and swop trailer fitted TPMS wheel sensors.

Service

Service Interval

Used for altering the EB+ service indicator. Both days and distance (miles or km) can be altered. The entered durations will be added to the current odometer reading and only become active when the Service Reset is actioned.

Service Reset

Used for resetting the EB+ service indicator. Note: The amended duration will be the internally stored service interval.

Info Centre

Language

The Info Centre 2 has multiple languages.

Start Screen

This menu allows the user to choose Info Centre functions to be displayed at start up, before the main menu.

The **Start Screen** menu allows the user to choose Info Centre functions to be displayed at start up, before the main menu.

- > None (if selected there will be no start screen)
- > Distance
- > DTC
- > AUX
- > Axle Load Sum
- > Language
- > Unlock
- > Tilt Angle
- > Tyre Pressure
- > User Defined (if selected go to user defined section below)

PIN

A PIN is used to protect a number of the Info Centre menus.

Unlock

Use this menu to unlock the Info Centre via a valid PIN.

Wheel Scale

Displays the EB+ wheel scale and sensor teeth settings.

Date Format

Allows the user to set the date format.

Date

The time and date stored in the Info Centre is used to record the time and date at which EB+ faults occur.

Time

Used to set the 24hr clock time.

Units

Use to select metric or imperial units for the Info Centre.

Contrast

Use this menu to adjust the LCD screen contrast.

Display

Self test function for the Info Centre display.

TPMS ID

Displays a complete list of configured wheels and sensor ID's and allows the operator to **swop** over wheel sensors (WUS).

LED Settings

LED Flash B+

Used to configure the action of the Service LED when the Info Centre is powered by the EBS.

LED Flash Batt

Used to configure the action of the Service LED when the Info Centre is battery powered.

Tilt Angle

Used to set the tilt angle before the Service LED flashes.

The user defined start screen can display up to 5 of the following items:

- > Odometer
- > Service
- > Service Interval
- > DTC
- > Stored DTCs
- > Lining Wear
- > Reservoir
- > Axle Load Sum

7) Coupling

Semi-trailer

- ◆ All semi-trailers are equipped with a 2-inch kingpin pursuant to the reference standard ISO 337 type A.

The technical specifications of this kingpin are as follows:

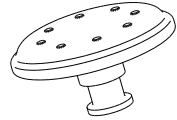
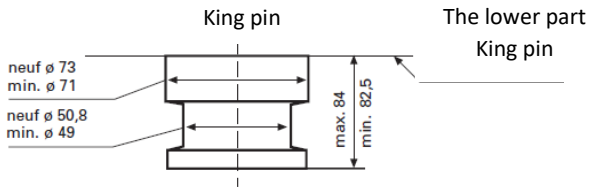

Trailer

- ◆ The trailer coupling system consists of a beam, a fixed or adjustable drawbar and a coupling eye.
- ◆ There are two different ring models: ISO and BNA.

ISO ring:

- Nominal diameter: 50.0 mm
- Maximum allowed wear: 51.5 mm

Note: ISO rings may be fitted with a casing wear ring.

BNA ring:

- Interior eye diameter : 68.0 mm
- Eye thickness : 42.0 mm
- Maximum allowed wear : 40.5 mm

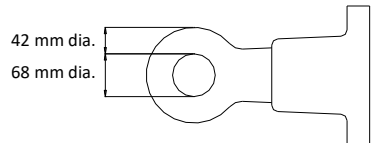
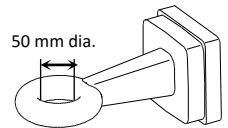

Repair and maintenance

- ◆ The coupling system may only be replaced by another with **identical technical specifications**.
- ◆ Every time the system is dismantled, all bolts must be replaced by new ones of the same technical specifications.

8) Electrical installations

Electrical circuitry

- ◆ The electrical system supplies all the interior and exterior lighting systems, along with the accessories that need an electrical power supply to operate. The system comprises a 3-socket junction box as standard, with an optional rear bypass box.
- ◆ The front junction box contains the interior lighting timing functions and a fuse on the interior lighting circuit. The body lateral/interior lighting is connected to the box using connectors.
- ◆ The generic schematics and optional wiring diagrams are attached in the appendices. These do not include any options or special features.

Connections

- ◆ Your vehicle is equipped with 3 sockets :
 - Two 7-pin sockets, 24N and 24S, that meet the requirements of ISO standards 1185 and 3731 respectively.
 - One 15-pin socket that meets the requirements of ISO standard 12098.
- ◆ An adaptor is necessary for connecting a 15 pin socket to the 7 pin sockets 24S and 24N, pursuant to ISO 12098 standard.

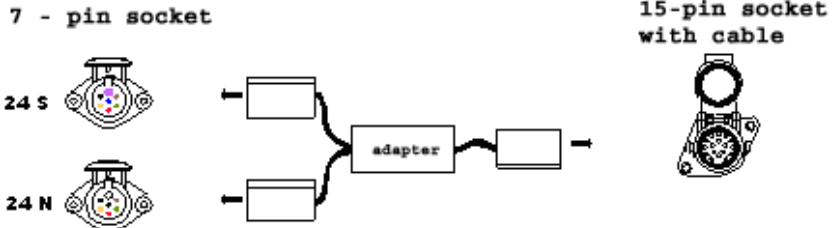

The pin-outs are indicated in the attachment, page 44.

Repair and maintenance

- ◆ Works may only be carried out by qualified, skilled professionals. Refer to the general wiring diagram on page 43 when working.
- ◆ When carrying out repair work, wire sections and fuse ratings must be respected.

👉 Modification of the electrical circuit without the approval of the CHEREAU technical department will invalidate the guarantee.

👉 Ensure that all cables and sockets are in good condition.

9) Landing gear

- ◆ Landing gear can operate at 2 speeds. The higher speed allows quick extraction and retraction of the telescopic tube when the semi-trailer is coupled. The lower speed is used to lift the semi-trailer when the supports are firmly on the ground.

☞ **Use of the higher speed is strictly limited to operations where the feet are not in contact with the ground.**

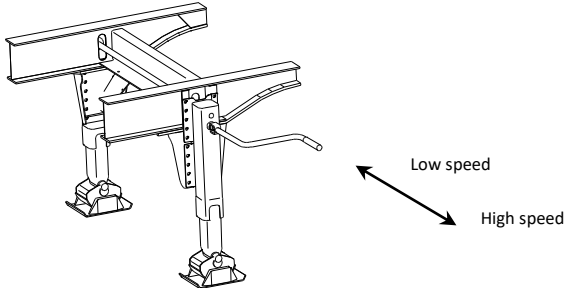

- ◆ The landing gear is lubricated and does not require any maintenance for 3 years. After 3 years, install a grease nipple on the prop and check the wear on the screw and nut. This lubrication and wear check should then be carried out annually.

10) Odometer

- ◆ The odometer is an optional piece of equipment which records the distances covered by the vehicle.
- ◆ The odometer may be a mechanical device, placed at the end of an axle, or electronic with a display unit located next to the raising/lowering switch.
- ◆ Distance is calculated on the base of the theoretical tyre radius and the number of wheel rotations performed.
- ◆ As the tyre radius changes depending on the load carried, it is possible that there may be a difference between the distance indicated by the tractor and that indicated by the trailer.

11) Lashing rings

- ◆ The lashing rings are optional for the lashing of vehicle loads.
- ◆ Various rings may be welded to the frame at the following points:
 - 2 at the back of the frame
 - 3 on each frame side (1 at the front, 1 by the landing gear and another one by the bogie).

12) Rear underride protection bar

- ◆ CHEREAU vehicles can be equipped with one of the following underride protection

bars, as required:

Standard type: normal use,

Ferry type: used for transport by boat.

- ☞ **If bars are replaced, use only the original grade screws.**
- ☞ **The rear underride protection bar is an officially approved system and should not be modified without the approval of the CHEREAU technical department.**

13) CHEREAU refrigeration unit fuel tank



- ◆ The CHEREAU refrigeration unit fuel tank is an optional element with a capacity of 250 litres, supplying the refrigeration unit. This option includes the following elements: a dipstick and a lockable cap.
- ◆ This tank meets the requirements of the Directive relating to liquid fuel tanks (70/221/EEC).
- ◆ The tank is held in place by two straps. During maintenance operations, check that the tank is fixed securely and that there is no movement.
- ◆ The use of bio-fuels is prohibited.

14) Rear protection

- ☞ **The rear protection systems do not remove the necessity for extreme care on the part of the driver when docking.**

- ◆ The rear “CHEREAU bumper” is an optional piece of equipment that effectively protects the rear of the vehicle during docking and loading.

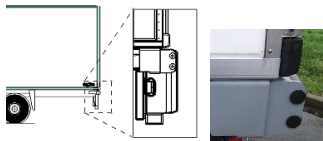

2 or 3-axle articulated version

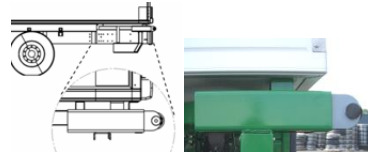

other vehicles version

- ◆ Rear protection device: as an option, rear protection buffers can be installed on the underride protection bar mountings or on the body loading sill.

15) Rear Detect-C

- ◆ The **RearDetect-C** system monitors the reversing zone behind the vehicle using ultrasonic sensors.
- ◆ Using **RearDetect-C**, the vehicle driver is assisted during reversing and particular when approaching loading docks.

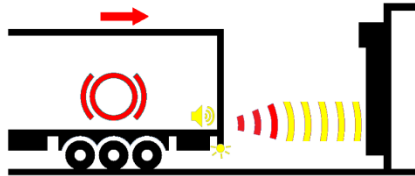

- ☞ **Extract from standard ISO 12155: Reversing radars are considered as an additional aid for a driver when reversing [,,,] but do not release him/her from a duty of care during such manoeuvres (it is not an alarm system for other persons in the vicinity).**
- ☞ **CHEREAU can in no way be held responsible for an accident resulting from the use of the product.**

Operation:

- ◆ The **RearDetect-C** system is activated when reverse gear is selected. From then on and according to the distance between the vehicle and the obstacle, a visual signal (from the two stalk lights) and an audible signal (from a buzzer) are emitted.
 - ◆ The detection of obstacles can then be described in several stages:
 - Slow flashing and beeps ----- distance between 2 and 3 m*
 - Rapid flashing and beeps ----- distance between 1 and 2 m*
 - Continuous flashing and beeps----- distance less than 1 m*
 - ◆ When the stopping distance is reached, the system automatically brakes the vehicle to immobilise it. The brakes are activated and then released, to allow the driver to make a final approach to the dock.
- ☞ **NOTE: If the vehicle reaches a speed in excess of 12 k.p.h. when reversing, the Rear Detect-C system is deactivated. In that case, the vehicle will not brake when approaching an obstacle.**

Silent mode:

- ◆ The buzzer can be temporarily stopped by engaging reverse gear twice, two seconds apart. This allows the system to be used noiselessly in residential areas, for example. This deactivation only remains in effect until reverse gear is engaged once more.
- ◆ Ultrasonic sensors use air-borne waves. Disturbed air can therefore have an effect on the system's operation: very heavy rain, very high winds, high levels of dust, thick snow or ice on the sensors, etc.
- ◆ On vehicles with manual transmission, the driver must depress the clutch, as soon as the system starts to brake the trailer. On vehicles with automatic gearboxes, the driver must reduce engine speed early enough, as some vehicles of this type increase engine torque under increased load.
- ◆ Ensure that sensor detection zones are kept clear of any obstacle that might be detected and cause nuisance braking during reversing (steps not folded away, padlock not properly stowed, etc.)

Servicing and repairs

- ◆ Any work on the **RearDetect-C** system must be done by qualified, authorised personnel.

Servicing and maintenance operations

1) General information

Observance of the servicing guidelines and prescribed service schedule is crucial for keeping the vehicle in good working order.

- ◆ The service schedule is based on average use. If the intensity of use is higher, the schedule must be adapted accordingly.

All servicing must be carried out by qualified, skilled professionals.

- ◆ Please refer to the corresponding chapters or annexes for information before any servicing work.

2) Washing

- ◆ To maintain it in good condition, the vehicle must be washed regularly to remove all external pollution.
- ◆ Non-aggressive cleaning products should be used for washing (pH between 5 and 9) at a temperature below 50°C.
- ◆ The washing lance should be kept more than 30 cm from the vehicle and pressure should not exceed 60 bars (or 60 cm for 180 bars) Do not wash electrical components excessively (connector, control box, etc.).
- ◆ Rinse copiously after washing.

3) Multi-axle bogie

Please see those parts of the operation and servicing manual referring to the multi-axle bogie.

- ◆ The multi-axle bogie consists of axles, brakes and suspension.

Service	Every (km)		
	3,000 1 week	30,000 1 month	90,000 1 year
Check brake pads for wear on disk brakes or stator assembly on drum brakes	●		
Check state of suspension cushions	●		
If fitted with self-steering axle : grease self-steering axle		●	
If fitted with self-lifting axle : check operation		●	
Check axle alignment			●



INNOVATION DRIVES YOU FORWARD

<i>Service</i>	Every (km)		
	3,000 1 week	30,000 1 month	90,000 1 year
If fitted with self-steering axle : check operation			●
If fitted with self-steering axle : adjust toe-in and wheel camber on self-steering axle			●

4) Brakes and suspension

<i>Service</i>	Every		
	3,000 1 week	30,000 1 month	90,000 1 year
Check ABS indicators	●		
Blow off air reservoirs	●		
Check seals on air line coupling heads	●		
Check filters		●	
Check pressure at coupling heads on tractor supply lines		●	
Check working order of and adjustment of load sensing-valve		●	
Check EBS system, using diagnostic software, to verify that there are no faults		●	
Check parking and back-up brake		●	
Check brake release push-button returns smoothly		●	
Checking the operation of the suspension raise and lower control		●	
Check air line hoses		●	
Check condition of brake chambers		●	
Check for air leaks		●	
Check that the internal raise/lower control operates correctly by operating it from the battery (optional). The batteries are maintenance free. Replace the batteries if an operating fault is noticed or at least every three years.			●

5) Lights and signalling

Service	Every (km)		
	3,000 1 week	30,000 1 month	90,000 1 year
Check condition of indicators	●		
Check that indicators are in working order	●		
Check condition of 24S and 24N sockets and 15-pin socket	●		

Replacing bulbs :

Unscrew the screws from the diagrams below,
 Remove the cabochon,
 Replace defective bulbs with bulbs of the same characteristics,
 Reposition the cabochon without pinching the gasket,
 Replace the screws with the appropriate tightening torque,
 Check that all functions are working properly,
 In case of non-operation, repeat the procedure.

RUBBOLITE M461 (E11 0098)

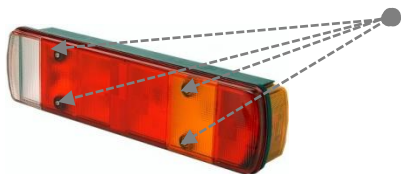

RUBBOLITE M360 (E11 0006)

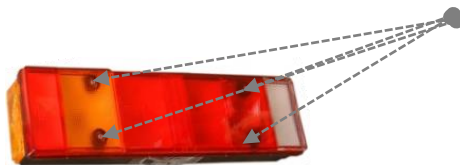

RUBBOLITE M463 (E11 0594)

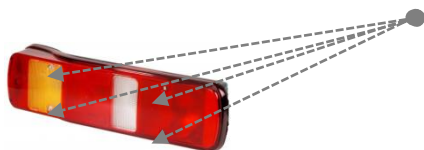

RUBBOLITE M464 (E11 5598)

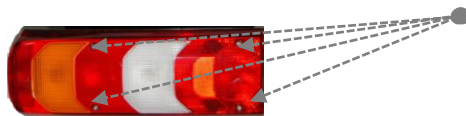

RUBBOLITE M462 (E11 0333)

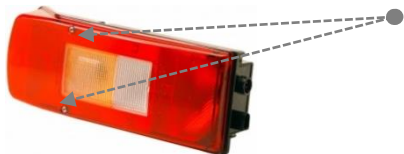

RUBBOLITE M465 (E11 0216)

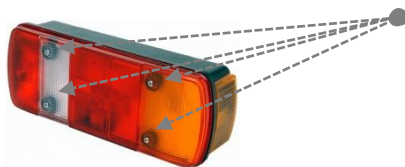

RUBBOLITE M802 (E11 1194)

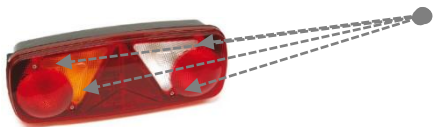

RUBBOLITE M811 (E11 0866)

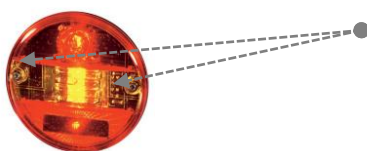

VIGNAL LC5 (E2 80005)

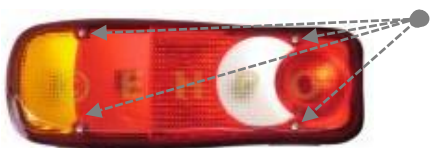

VIGNAL LC7 (E2 88035)



VIGNAL LC8 (E2 2040)



6) Coupling

<i>Service</i>	Every (km)		
	3,000 1 week	30,000 1 month	90,000 1 year
Grease knuckle pin and fifth wheel	●		
Visual check of coupling plate mechanisms: hitch tongue, ring. No part should show signs of mechanical damage or advanced corrosion.	●		
Check wear on turntable		●	
Check wear on coupling eye (if necessary)		●	
Check torque of beam bolts (if necessary)		●	
Check the degree of wear on the coupling plate metalwork. The inspection should be carried out after a complete degreasing; check that there are no cracks or significant distortion.			●
Check torque of turntable bolts			●
Check torque of fifth wheel fitting bolts (if necessary)			●

7) Wheels and tyres

<i>Service</i>	Every (km)		
	3,000 1 week	30,000 1 month	90,000 1 year
Check tyres for wear	●		
Check tyre casing	●		
Check condition of wheels	●		

8) Rear protection

<i>Service</i>	Every (km)		
	3,000 1 week	30,000 1 month	90,000 1 year
Check the condition of the rear buffers			●
Check the condition of the rollers, spindles, slides and shock absorbers (visual inspection)			●

Check slide lateral play < 5 mm			●
Check the tightening torque on the mounting screws			●
Retighten the bumper pre-stressing tool			●

9) Fuel tank

<i>Service</i>	Every (km)		
	3,000 1 week	30,000 1 month	90,000 1 year
General visual inspection: no leaks, gauge operates properly	●		
Check that mounting screws and straps are tight	●		
Drain the tank			●
Checking the general condition and fixing of the interfaces connecting the tank to the chassis		●	

10) Landing gear

<i>Service</i>	Every (km)		
	3,000 1 week	30,000 1 month	90,000 1 year
Visual check of the leg stand for cracks and distortion.	●		
Grease the screw and nut (first greasing after 3 years)			●
Check the wear on the screw and nut			●

11) Accessories fixed under the bodywork

<i>Service</i>	Every (km)		
	3,000 1 week	30,000 1 month	90,000 1 year
Checking the condition and fixing of all accessories fixed on the chassis		●	

APPENDIX I: Electrical adapters

Pursuant to ISO 12098 standard.

15-pin connector (ISO 12098)
Installed on the tractor vehicle

7-pin connector
Installed on the tractor vehicle

- 1- Left direction change indicator
- 2- Right direction change indicator
- 3- Rear fog light
- 4- Common return for contacts 1 to 3 and 5 to 12
- 5- Rear left side marker and clearance lights and rear registration plate light
- 6- Rear right side marker and clearance lights and rear registration plate light
- 7- Stop lights
- 8- Reversing lights
- 9- Permanent electrical supply (+24V)
- 10- Inertia brake reverse gear lock-out release and steering axle lock
- 11- Moving off/acceleration traction control system
- 12- Axle lifting device
- 13- Common return for contacts 14 and 15
- 14- CAN_H meeting ISO 11992-1 and ISO 11992-3
- 15- CAN_L meeting ISO 11992-1 and ISO 11992-3

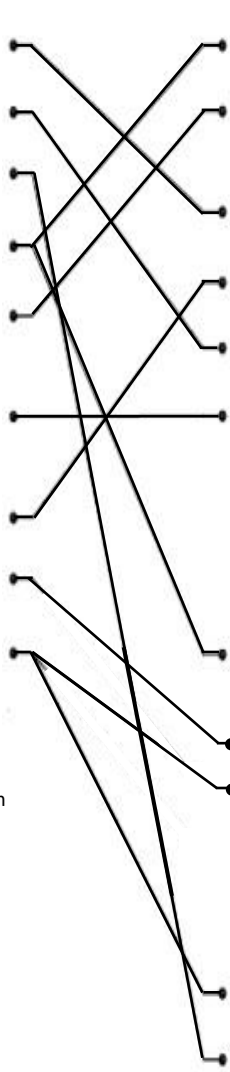

- Connector 24N (ISO 1185)**
- 1- Common return
 - 2- Rear left side marker and clearance lights and rear registration plate light
 - 3- Left direction change indicator
 - 4- Stop lights
 - 5- Right direction change indicator
 - 6- Rear right side marker and clearance lights and rear registration plate light
 - 7- Braking control for trailers
- Connector 24S (ISO 3731)**
- 1- Common return
 - 2- Not allocated
 - 3- Reversing light
 - 4- Permanent electrical supply (+24V)
 - 5- Sensor with common return
 - 6- Power supply controlled by ignition switch
 - 7- Rear fog light

APPENDIX II: Electrical wiring

- ◆ Standard system

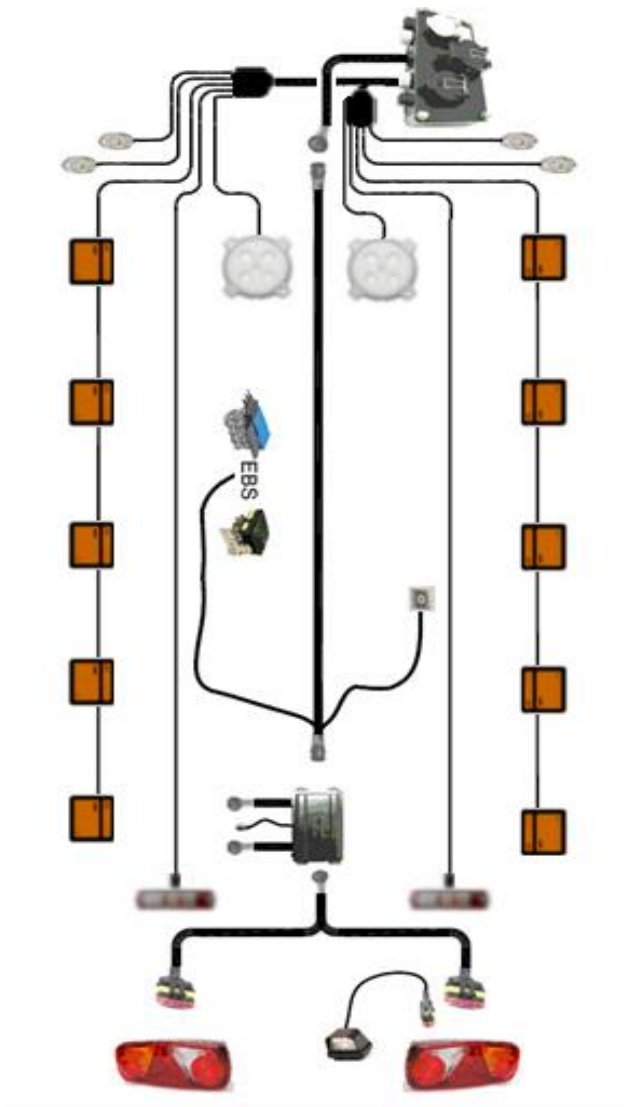

- ◆ Optional system

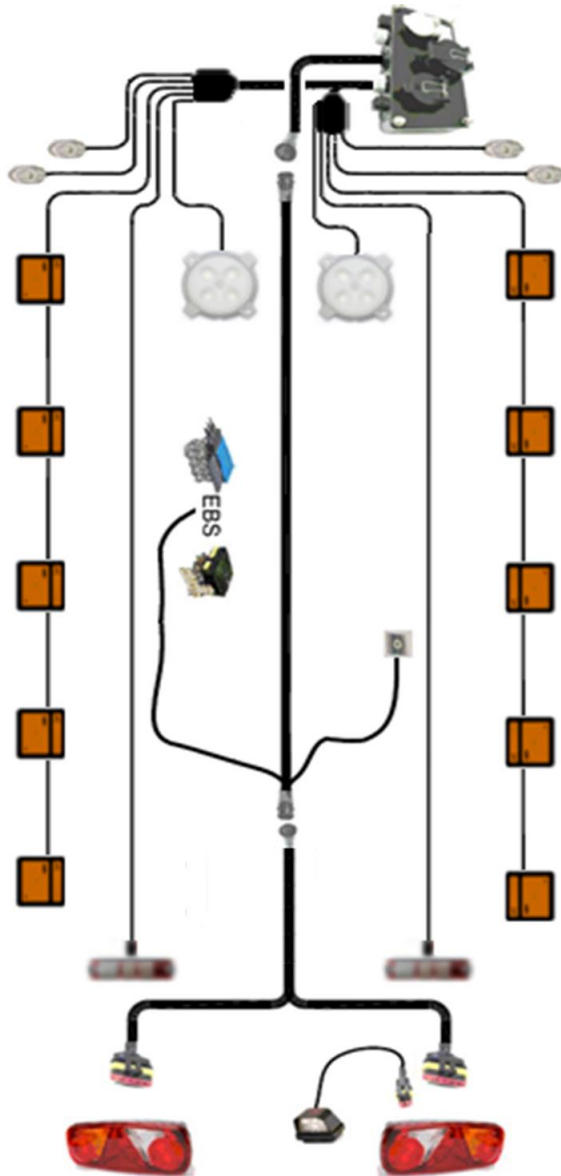

- ◆ Version with **Flex-C LED** and TMU

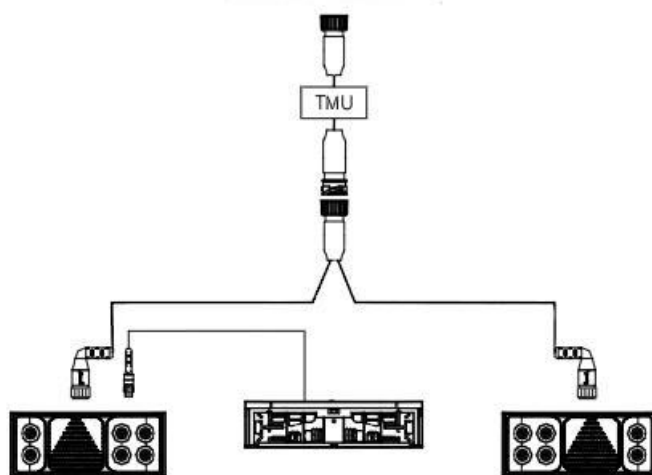

◆ Colour / function coding

<i>Colour</i>	<i>Function coding</i>
Yellow	LH direction indicator
Green	RH direction indicator
Blue	Rear fog light
White	Common return
Black	LH rear sidelight(s), LH clearance lights and rear number plate lighting.
Brown	RH rear sidelight(s), RH clearance lights and rear number plate lighting
Red	Brake lights
Pink	Reversing light
White/Orange	Permanent electrical supply
Grey	Tag axle locking
White/Black	Anti-wheelspin system during startup and acceleration
White/Blue	Axle raising
White	Common return for pins 14 and 15
White/Green	CAN_H
White/Brown	CAN_L
Orange	Timing supply
White	Timing earth
White/Red	Timer control 20 mm
White/Yellow	Timer control On/Off
Dark Green	Timer output (overhead light)

APPENDIX III: Wheels and tyres

1) Speed indicators

Speed codes	Speed (km/h)
F	80
G	90
J	100
K	110
L	120
M	130

2) Load indicators

Indication	Load (kg)	Indication	Code (kg)
133	2060	147	3075
134	2120	148	3150
135	2180	149	3250
136	2240	150	3350
137	2300	151	3450
138	2360	152	3550
139	2430	153	3650
140	2500	154	3750
141	2575	155	3875
142	2650	156	4000
143	2725	157	4125
144	2800	158	4250
145	2900	159	4375
146	3000	160	4500

APPENDIX IV: Torque parameters

Turntable fixing bolts:	19 daN.m
Eye: plate fixing screws:	20 daN.m
Landing gear fixing nuts:	19 daN.m
Fixing bolts on the front-end pivot (trailer):	21 daN.m
Bogie:	Refer to manufacturer's documentation

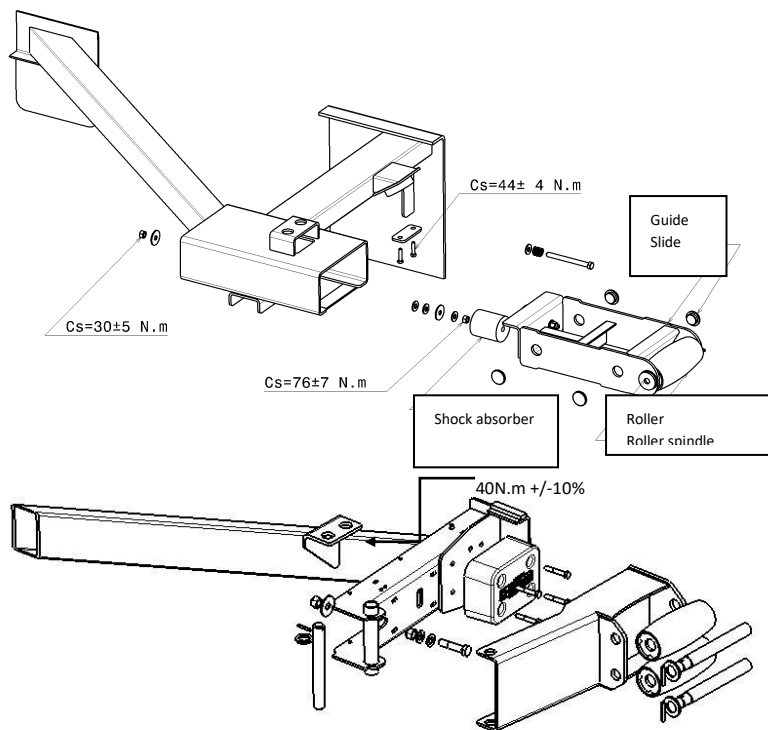

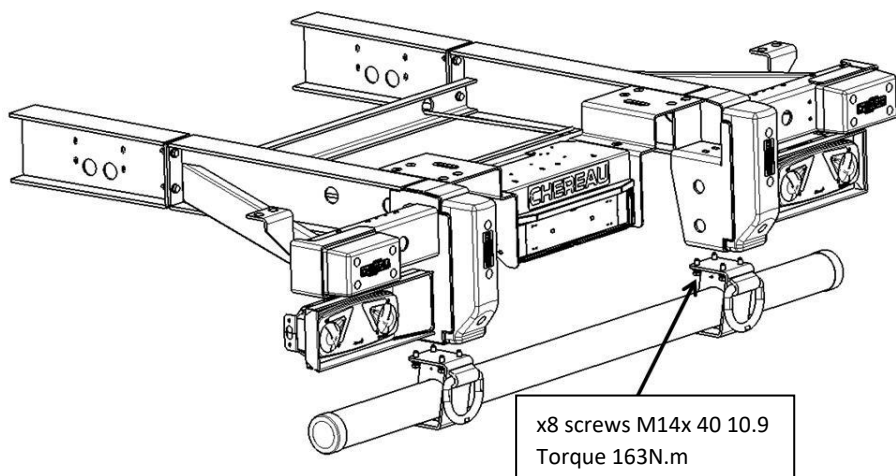
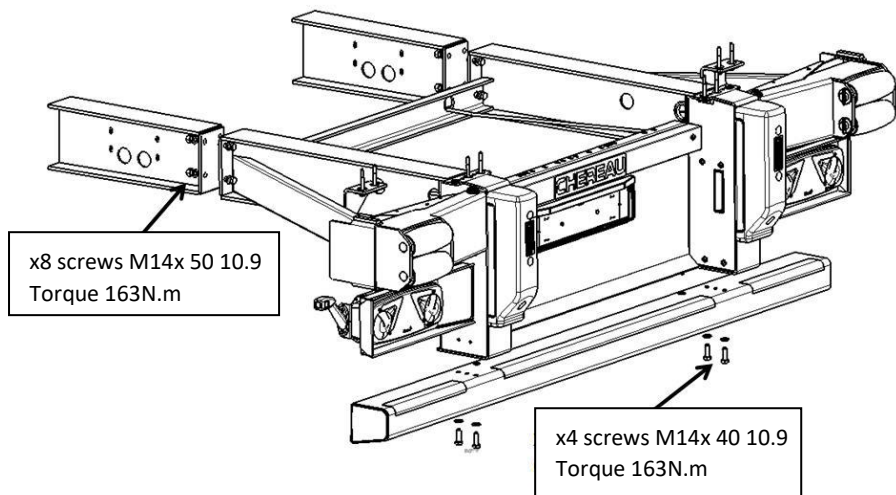



INNOVATION DRIVES YOU FORWARD

Our aim is to supply you with user instructions that match your needs as closely as possible.

In this regard, do not hesitate to let us know your comments and suggestions which could assist us in improving the quality of this document.

JEAN CHEREAU SAS
ZI le Domaine – 50220 DUCEY-LES-CHERIS
FRANCE

Tél: + 33 (0) 233 580 600

E-mail: contact@chereau.com

www.chereau.com



INNOVATION DRIVES YOU FORWARD



BODYWORK



INNOVATION DRIVES YOU FORWARD

Introduction

- ◆ This manual is designed to help you operate and maintain your CHEREAU vehicle. It should always be kept in your vehicle and read by all users of the vehicle and maintenance staff.
- ◆ The CHEREAU isothermal body is designed for the transportation of goods or products at controlled temperature. All equipment built into the CHEREAU body has been studied in order to achieve the best quality transportation.
- 👉 **Please note that CHEREAU bodies are designed to be used by freight professionals who in turn, have the responsibility to ensure that the vehicle is used in compliance with current local regulations.**
- ◆ In order to ensure the safety of transportation and preserve the quality of goods transported, close application of the guidelines concerning use and maintenance provided in this manual is strongly recommended.
- ◆ CHEREAU reserves the right to make any alterations deemed necessary for improving its products, on its entire product range, without prior notice.
- ◆ Any modification or addition to equipment must be submitted to CHEREAU for prior agreement.

IT/LIV/203.rev03

Identification

- ◆ All CHEREAU bodies are identified by the manufacturer's plate located on the front face of the body. This plate indicates the type and the model of the body as well as the serial number and the date of manufacture.

☞ **The serial number of the body must be quoted in all correspondence.**

- ◆ Manufacturer's plate:

	Jean CHEREAU SAS FRANCE Tel : +33 (0) 233.580.600 Fax : +33 (0) 233.584.479
http : www.chereau.com	
Numéro de fabrication	<input type="text"/>
Date de construction	<input type="text"/>
Modèle	<input type="text"/>
Type	<input type="text"/>

ST11DF004 rev08

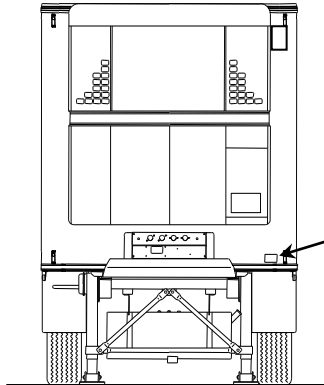

manufacturer's plate

Cleaning

- ◆ Regular cleaning and maintenance are the only way to guarantee a good level of cleanliness and compliance with hygienic requirements in transportation.
- ◆ The locations on the body that are most exposed to dirt are the seals and rails. Special attention should therefore be paid to cleaning all parts of these items.
- ◆ Parts should be washed using non-aggressive products (pH between 5 and 9) and at a temperature below 50°C.
- ◆ The washing lance must be held at least 30cm away from the surface and the pressure should not exceed 60 bars (or 60cm for 180 bars). Do not be too insistent on electrical components (connector, control box, etc.)
- ◆ Rinse thoroughly after washing.
- ◆ The grids protecting the refrigeration unit evaporator must be cleaned regularly using a hand brush. This can only be carried out when the unit is not in operation.

Prohibited cleaning products:

- Abrasive cleaning products,
- Strong alkaline solutions (ammonia, caustic soda, etc.),
- Organic (acetone), chlorinated (trichloroethylene) or aromatic (xylems, toluene) solvents.

Use

1) Temperature inside the body

During loading, both the temperature inside the body and the loading temperature should be equal to that required during transportation.

 **The use of all or part of the body during transport at a positive temperature, following use at a negative temperature, requires equipment inside the body to be defrosted; this should be taken into consideration when using equipment, so as not to damage the merchandise being transported.**

1) Rear doors:

- ◆ Standard models:
 - First open the right door.
 - Fully turn the handle to 90° to release the seal and de-pressurise the interior of the vehicle, thus facilitating opening.
 - Always use the doorstop to maintain the door in the open position (see page 60).
- ◆ For manual roller shutter doors:
 - Unlock the curtain handle.
 - Raise the curtain.
- ◆ For electric and pneumatic roller shutter doors: see their user manuals.
- ◆ It is important to keep the number and duration of openings to a minimum in order to prevent warm and humid air from entering the body.

2) Loading: general rules

- ◆ Always switch off the refrigeration unit during loading.
-  **Only lifting devices with a maximum load of 5 tons may enter the body.**
- ◆ Skidding by lifting devices while operating on the floor is prohibited.
- ◆ When loading, avoid any contact or collision with the sidewalls of the body.
 - ◆ Distribute the load in a way that allows **air to circulate freely**. Air must be able to circulate underneath, above and down the sides of the cargo. Air must be able to circulate freely above, below and around the sides of the load. Space must also be left in front of the load, to ensure that return of circulating air is possible (see the diagram below).

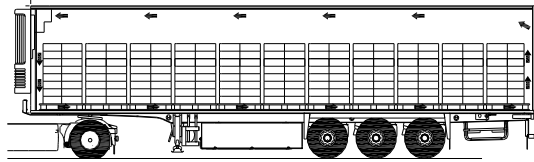

- ☞ **The front side of the body, as well as 15 cm between the top of the cargo and the ceiling.**
- ☞ **When inspecting ventilation ducts, check that the load cannot block the ducts.**
- ◆ The load must be distributed **evenly, along and across the loading area**. Ensure that the maximum load parameters as displayed in the documentation and on the plates of both the tractor and the trailer, are respected:
 - PTR: gross permitted weight of the vehicle.
 - PTC: total permissible loaded weight per vehicle.
 - Bogie weight
- ◆ Loading a body with several compartments:
 - Observe the guidelines for using bulkheads, page 62.
 - Use the available lashing devices.
 - Never use bulkheads to secure cargo.

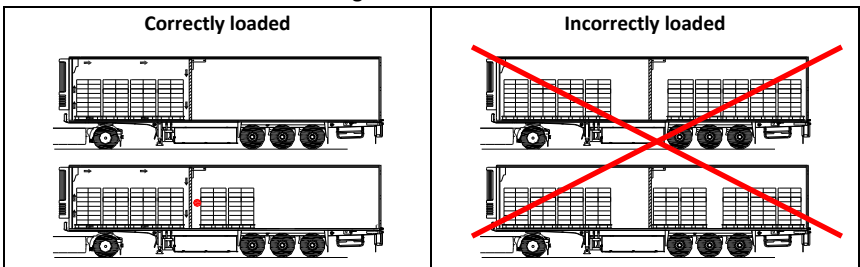

- ☞ **The evaporator inlet and outlet must always be kept unobstructed.**

3) Using the auxiliary equipment

- ◆ The use of certain auxiliary equipment can facilitate loading operations (tailgate, LEVIAND...).
- Do not use this equipment for any tasks other than those for which they were originally designed.
-  **All safety guidelines set out in the operation manual for each machine must be strictly observed.**

4) Lashing the cargo

- ◆ All cargo should be firmly secured in order to prevent it moving during transport.

Eléments d'arrimage

- ◆ Use the lashing points on the body (belt rails, self-tightening grids or ridge girders) to immobilise the cargo and comply with the regulations pertaining to their use. (see pages 66 to 68).
-  **When using lashing straps do not attach them vertically in relation to a sidewall (Please follow the guidelines for the use of belt rails on page 66).**
- ◆ When using ridge girders, ensure that the elevated load is securely fastened.

Hanging systems

- ◆ When using hanging rails, check that bolts are properly closed and that hanging loads are properly stowed.
- ◆ Before shutting the doors, ensure that the ends of rails are blocked to avoid the goods falling when the doors are opened.

5) Closing the doors

- ◆ Before closing the doors, ensure that the space between the closed doors and the cargo will be sufficient to secure the free circulation of air (minimum 6 – 8 cm).
- ◆ Close the doors and bolt the handles.

6) Cargo temperature

- ◆ Once loading is completed and doors firmly closed, set the refrigeration unit thermostat to the requested temperature and switch on the unit. (Please refer to the Refrigeration Unit Operation Manual).

Isothermal chamber

- ◆ The quality of the thermal insulation and an excellent mechanical structure are the two main characteristics of the isothermal chamber. Advanced performance in these two areas is secured through the use of special materials produced using technologies specifically designed for this application.

1) Structure

- ◆ The isothermal chamber consists of rigid, single panels bound together with a continuous mechanical and chemical linkage, assuring perfect homogeneity of the structure and excellent continuity in thermal insulation.

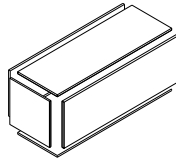

- ◆ Each panel is fabricated using a “sandwich” structure bonding the exterior walls to the insulating foam. This structure was developed with a view to achieving and maintaining optimum mechanical qualities while providing excellent insulating properties.

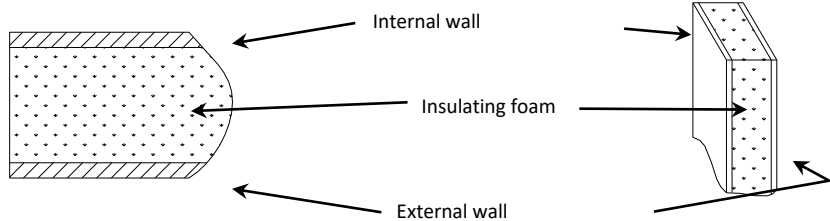

1) Thermal efficiency

- ◆ Isothermal efficiency is measured using the overall coefficient of heat transfer " K ", calculated on the basis of the measurements taken on prototype vehicles in an authorised laboratory. This coefficient guarantees the given degree of insulation quality and is used to determine the refrigerating power which a unit needs to deliver.
- ◆ The lower the coefficient, the better the insulation and the lower the refrigerating power needed to maintain the interior temperature. This is why particular care is taken when designing and manufacturing your vehicle body in a continuous effort to improve its overall coefficient of heat transfer.
- ◆ Radiation causes the heating of bodies exposed to sunlight, resulting in excess consumption by the refrigeration unit. To limit the effect of this radiation, the base colour chosen for the body was white, giving it an excellent reflective quality. We do not recommend the use of dark coatings on the body, as this would impair performance.

2) Coatings and protection

Coatings

- ◆ The interior wall coating consists of layers of glass-polyester laminate (with an optional stainless steel skin).
- ◆ The floor is coated to reduce wear. This is done either by applying an anti-slip coat of polyester resin with glass fabric, or aluminium coating with integrated anti-slip surface.

Protection

- ◆ The most commonly used areas are protected by additional features such skirting and frontal surface protectors (optional).

3) Openings

Rear doors and side openings

- ◆ CHEREAU bodies are equipped with stopping devices which must be used when loading or unloading to ensure alignment of the open doors with the side.

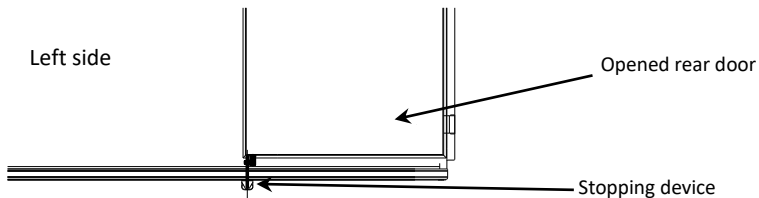

- ◆ Door open sensors

The door opening system may be equipped with a optional sensor to control the various equipment. The sensor is situated on the upper latch. It can be accessed by removing the rear running light support.

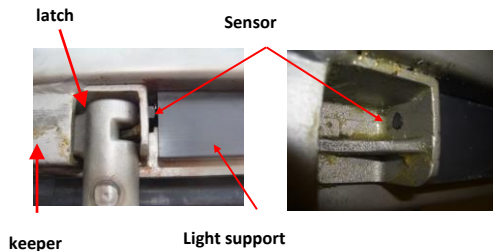

Isothermal roller

For the use and maintenance of isothermal roller shutter doors, see the specific manual supplied.

4) Repair and maintenance

- ◆ In order to preserve the original quality and performance of your isothermal chamber, all its components must be kept in good working order and the following rules observed:
 - Monitor the tightness of the doors and keep the seals in good condition. Replace the seals as soon as this is necessary.
 - Immediately organise repair of the body if any of the sidewalls is punctured as a result of an impact, in order to avoid the infiltration of humidity which could reduce the vehicle's thermal efficiency.
 - ◆ All servicing work must be carried out by qualified, skilled professionals.
-  **The insulation qualities of the chamber can only be maintained if all sealing elements are in good condition.**
- ◆ In order to maintain the original specifications, all repair and maintenance works must be carried out in the proper manner.
Please contact our customer services for all repair and maintenance work:

JEAN CHEREAU SAS

ZI le Domaine – 50220 DUCEY-LES CHERIS-
FRANCE

Tél: +33 (0) 233.893.893

E-mail: support@chereau.com

Internal equipment

- ◆ This chapter provides a non-exhaustive account of auxiliary equipment which may be installed on your vehicle as an option, as well as corresponding operating instructions.

1) Bulkheads

Bulkheads are used to divide cargo areas into several compartments.

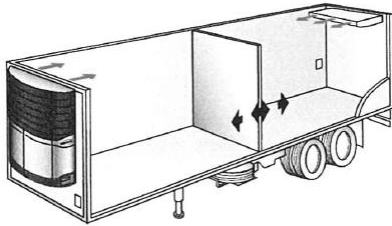

- ☞ **Remember: Never use bulkheads to secure cargo.**
- ☞ **In order to protect the bulkhead elements, two red safety stops limit the angle between the bulkhead and the roof to 90°. If this angle is exceeded, the screws fail and the stops fall. If this occurs, check the condition of the bulkhead and replace the stop screws.**

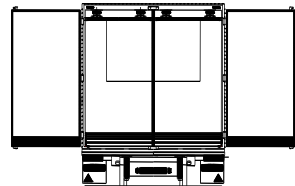
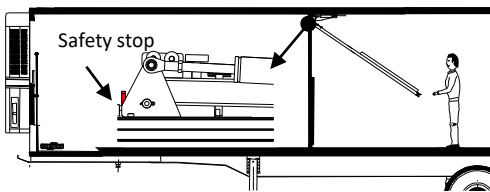

- ☞ **The use of handling equipment to lift bulkheads is strictly prohibited.**

Operating a mobile bulkhead

- ◆ To move a bulkhead:
 - First pull the vertical blue strap to unlock it and then lower the partition to within reach.
 - Lower the bulkhead to mid-height, using the lower part of the handle.
 - Move the bulkhead to the desired position.
 - Lower the bulkhead.
 - Push the handle back in against the bulkhead, and close the decompression flap (where fitted).

- ◆ To lift a bulkhead to the ceiling:
 - Pull the handle towards you.
 - Release the handle once the bulkhead is at mid height.
 - Pull the partition down by hand, holding on to the storage handle until it is fully locked in place. Check that it is locked in place by pulling gently on the handle
 - ◆ Distance in relation to the refrigeration unit in the vertical position, comply with the positions shown on the side walls inside the vehicle.
-  **Be careful not to knock against the bulkhead during loading, as this might cause damage.**

Repair and maintenance

It is very important to keep both the bulkhead and its seals in good condition in order to secure perfect insulation between different compartments.

- ◆ Visual check:
 - Condition of the seals.
 - Condition and presence of U-shape spacers at the base of the bulkhead.

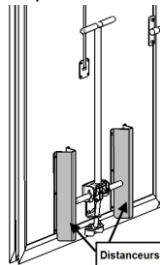

- Condition of the rails and fixings, replace rivets that are not secure and the rail, if distorted.
- Condition of panels (holes, distortion, etc.)
- Condition of rubber end stops (ends of rails)
- Condition of brakes

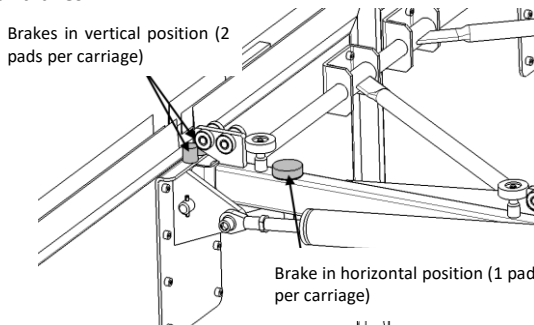

- Presence of bulkhead corner stops

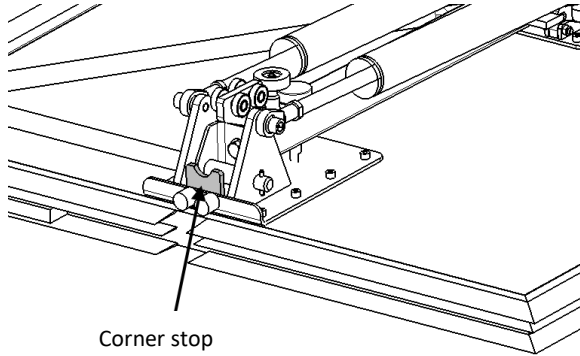

Corner stop

◆ Functional test:

- Locking into the roof
- Locking using the manoeuvring handle (foot, mechanism)
- Longitudinal movement of the bulkhead (bearings)
- Lifting mechanism:
 - a) Position the bulkhead in the centre of the body
 - b) Make an angle in relation to the roof:
 - 45° for gas cylinder bulkheads
 - 25° for spring cylinder bulkheads
 - c) Release the bulkhead
 - If locking occurs spontaneously, the cylinders are correct (repeat the operation three times)
 - If locking does not occur, check the alignment of the carriages and the condition of the entire lifting mechanism.
 - If necessary, adjust the cylinder pre-stressing screw.

◆ Lubrication:

Lubricate the lifting joint, the bolt and the locking finger on the carriage with food-grade grease.

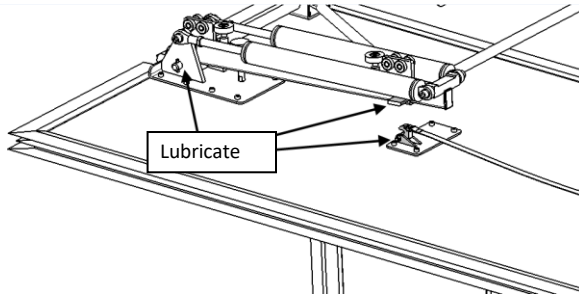

◆ Dismantling the bulkhead::

To remove the bulkhead from the rail, it is recommended that you remove the rail at a connection point.

- Remove the first three fixing rivets from the rail starting from the connection.
- Place a wedge between the roof and the rail, to keep it bent.
- Place another wedge of sufficient thickness between the carriage and the bulkhead panel, to release the horizontal brake completely.
- Make arrangement to take the weight of the bulkhead, once it is freed from the rails (pile of pallets, board lifter, etc.).

☞ **Warning: Weight over 150 kg.**

- Roll the bulkhead towards the freed connection to remove the carriage from the rail.

☞ **If the vehicle is covered by ATP conformity, the bulkheads must not be modified.**

2) Meat hanging systems

- ◆ The meat hanging system allows suspended meat to be transported. A specially reinforced part of the roof is used to support the suspended weight.

☞ **Suspension systems should never be fitted to vehicles not designed for such use.**

- ◆ There are 3 types of system :

- Tubular single-rail system,
- Sliding system,
- Dual-rail system.

☞ **Only hooks designed for a specific system may be used.**

☞ **Tubular single-rail system**

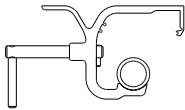

Unbolted bracket

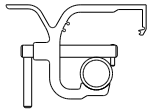

Bolted bracket

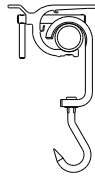

Bracket with hook

☞ **It is imperative not to exceed 250kg of loading per stem.**

☞ **Sliding system**

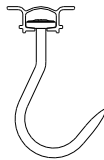
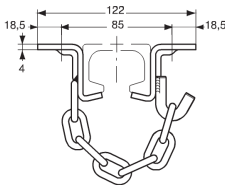

Slide with suitable hook

☞ **Dual-rail system**

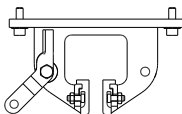

Unbolted bracket

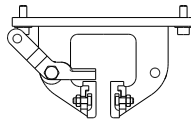

Bolted bracket

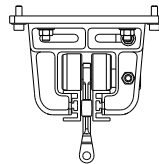

Bracket with hook

☞ **It is imperative not to exceed 400kg of loading per stem.**

☞ **Maintenance**

Only elements with identical specifications may be used to replace hanging elements.

3) Lashing rails

Rows of rails attached to the sides and/or the ceiling and floor of the vehicle are designed to facilitate placement and lashing of the cargo.

Rows of rails can either be flush or raised.

Lashing rail for straps and beams

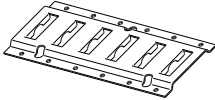

- ◆ Used with straps :
 - Place the strap over the cargo..
 - Tighten the strap.

→ The use of ratchet lashing straps is not permitted.

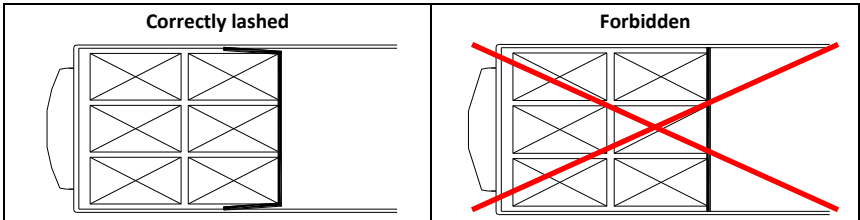

Lashing rail for bars or beams

Lashing bars and beams are only designed for lashing. They should never be used as

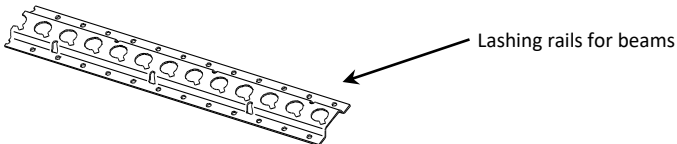

intermediate floor support.

- ◆ Use:
 - Place the bar or beam next to the cargo to be lashed.
 - Unlock one side of the bar or beam.
 - Place the bar or the beam onto the rail.
 - Lock that end.
 - Repeat the same operation with the other end.

4) Self-tightening grids

- ◆ Self-tightening grids are used to maintain the cargo in its position.

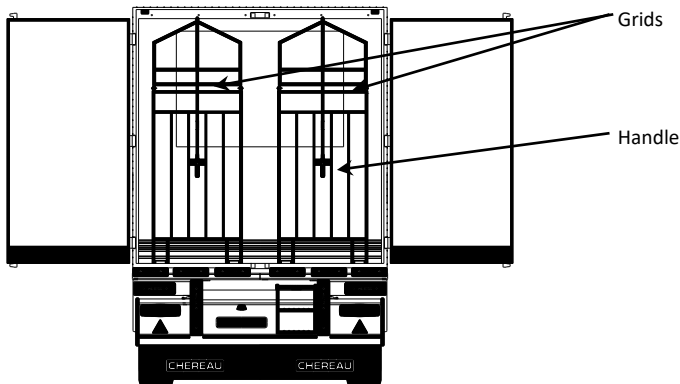

- ◆ Self-tightening grids are adapted to the dimensions of each body; consequently they may not be used with another vehicle.
- ◆ Operation :
The grids are mounted on the ceiling, on a guide or on a rail.
To move the grid:
 - Unlock the grid.
 - Slide the grid or take it out of the rail.
 - Place the bottom of the grid against the cargo to be fixed and keep in that position using your foot.
 - Sliding the grid, place its top end into the corresponding guide rail so that its position is fully vertical.
 - Lock the grid.

Repair and maintenance

- ◆ It is important to maintain the grid caps in good condition to avoid damaging the chamber coating.
- 👉 **Only an identical grid may be used to replace another one (please indicate the body serial number when ordering replacements).**
- 👉 **It must be possible to lock the grid without using a great deal of effort. If the amount of effort required to lock the grid ever seems abnormally high, this means that the grid is not meant for that vehicle.**

5) Intermediate flooring

Intermediate flooring is an option which allows the cargo to be placed on two different levels. The system consists of two transverse beams mounted on vertical rail supports.

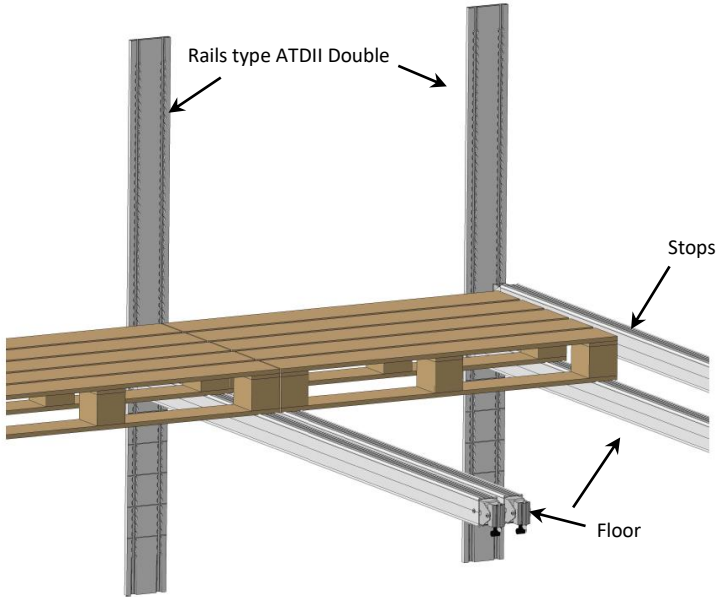

Operation

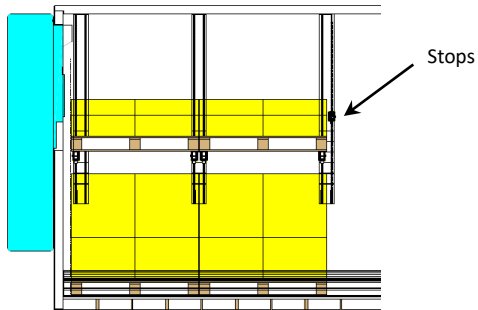

- ☞ Never adjust the height of a beam, while you are underneath it.
- ☞ Always comply with the maximum loading indicated on the beam.

- ◆ To modify the height of a beam :
 - Unlock both ends of the beam with the pole stored in the back of the vehicle.
 - Slide the beam to the desired height.
 - Ensure that the beam is completely horizontal.
 - Lock the ends of the beam.
 - Ensure that the beam forms a horizontal floor with its counterpart.
 - Store the cam in the rail on the right as you enter the vehicle.
- ◆ To stow the cargo :

Secure the cargo by placing a horizontal beam in front of it.

Repair and maintenance

- ◆ Always use only a beam with identical specifications to replace another one.

6) Multideck-C

Description:

Multideck-C is a rail and beam system which makes it possible to stow a load at two heights, and also to secure it horizontally.

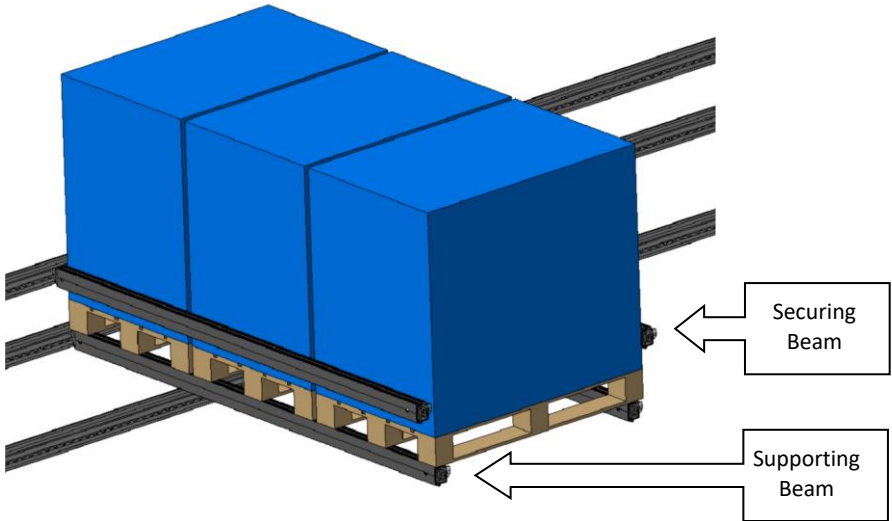

Multideck beams are captive and slide in a system of rails.

Multideck beams can be arranged as desired to carry or secure loads in the service rails zone (in black below) and then stored in a special storage zone at the rear of the vehicle (in blue below) when not in use.

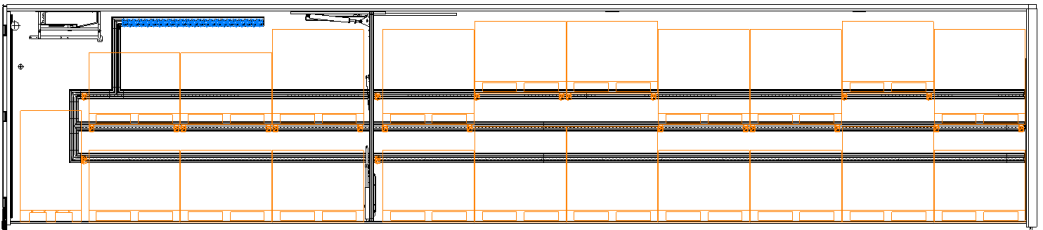

Refer to the user instructions, displayed at the rear of the vehicle, each time that the system is used.

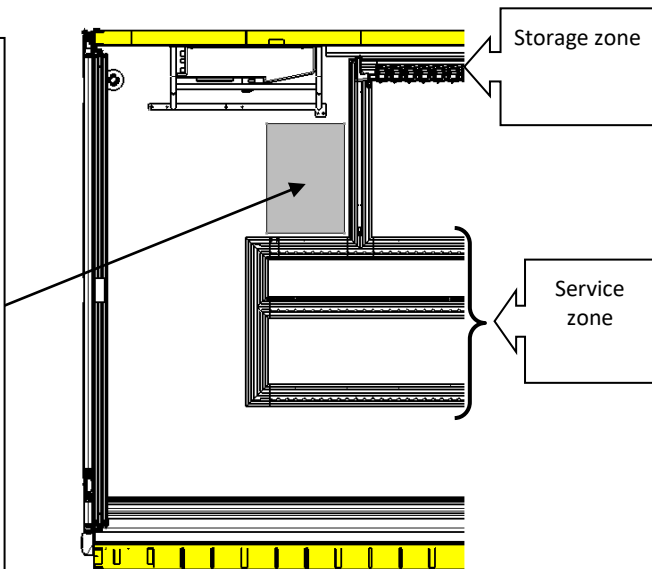
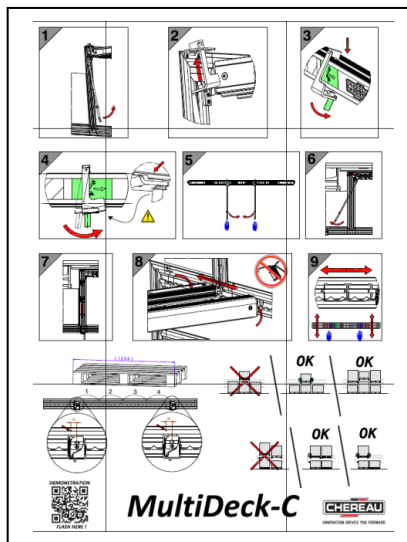

- ◆ Beams slide in the rails when in the horizontal position (1), and are locked in the longitudinal axis when vertical (2).

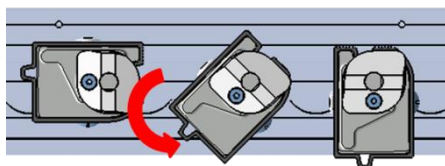

Instructions for use:

◆ **Pole storage**

IMPORTANT: the poles are not identical; there is a right-hand pole (blue marking) and a left-hand pole (green marking), stored on the right and left sides of the body respectively.

1) Removing the poles from their respective storage positions. Pull the handle out at an angle to remove it from the vertical rail.

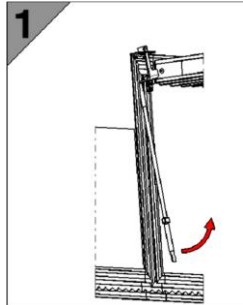

2) Gently lift the poles, so that they are released from their position, hooked over the upper rail.

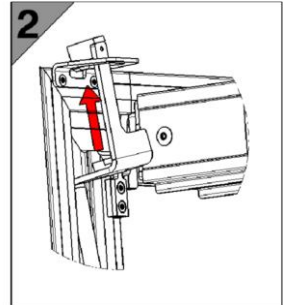

◆ **Handling the beams**

3) Fit the poles into the groove in the top of the beam and push them against the rear-face surface of the beam, taking care to position the poles in the colour-coded areas.

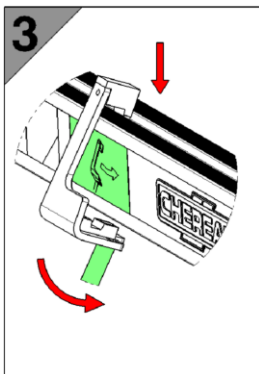

LEFT pole attachment zone

RIGHT pole attachment zone

- 4) Lock the poles by angling the handle inwards, ensuring that the bottom of the hook part of the pole locates against the lower rib of the beam.

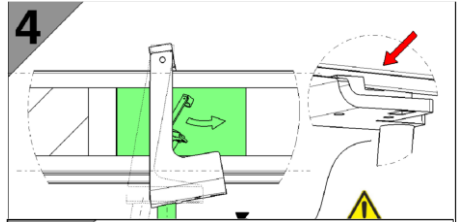

- ◆ 5) **IMPORTANT: hold the poles locked (in the vertical position) to move the beams.**

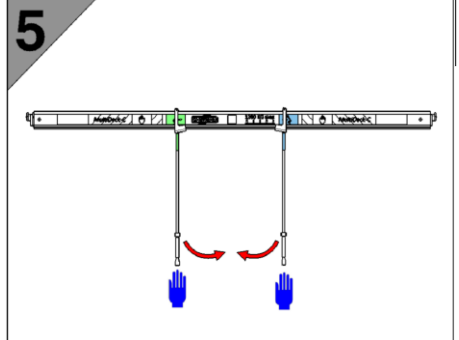

- 6) Tilt the beam slightly and pull it towards the rear, so that it passes over the "fall prevention" device on the upper rail.

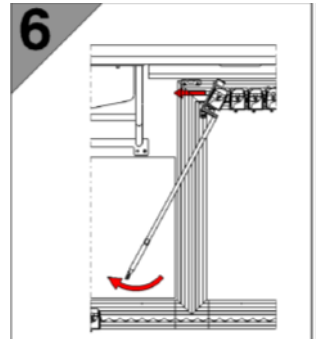

- 7) Once it reaches the stop on the vertical rail, return the beam to the vertical position and lower it carefully on to the horizontal rail. Remove the poles from the beam. Repeat the operation until the required number of beams has been lowered. Replace the poles in their respective storage positions, once the operation is complete.

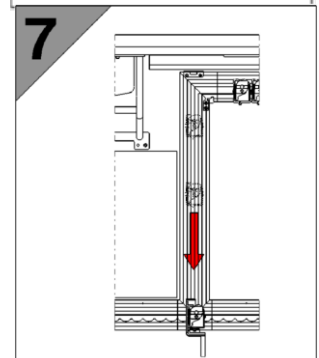

8) Rotate the beam a quarter turn by hand and slide it along the rail system to the desired position.

Return the beam to the vertical, locating it in a notch to lock it in position.

Do not lubricate the rails or beams.

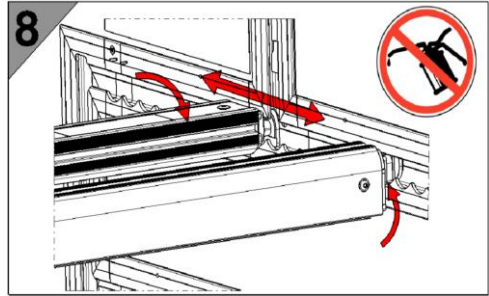

N.B: Beams may be pushed together and moved in pairs.

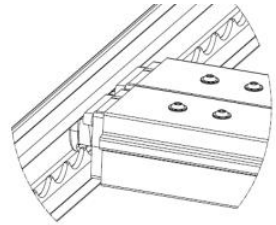

◆ Loading recommendations

➤ Beam position references

There are references on the upper part of the horizontal rails.

N.B: A 1200 x 800mm pallet requires a spacing of five references. Use spacing X to find the reference for each beam position.

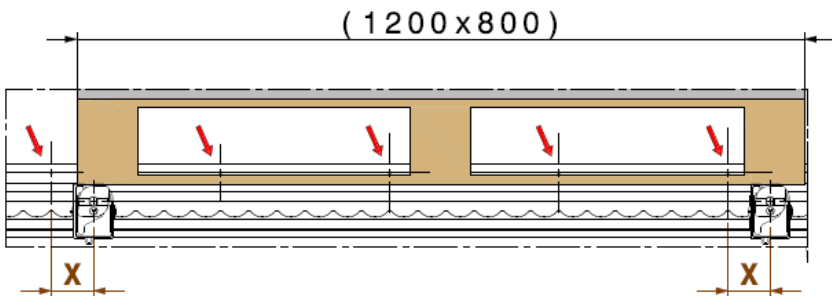
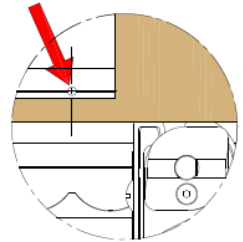

➤ **Load securing**

Single pallets, and also the first and last pallets in "double-floor" operation, cannot be on level 1, if they are to be secured.

➤ **Recommended spacing for securing beams**

The spacing between a "double-floor" beam and a securing beam is two notches.

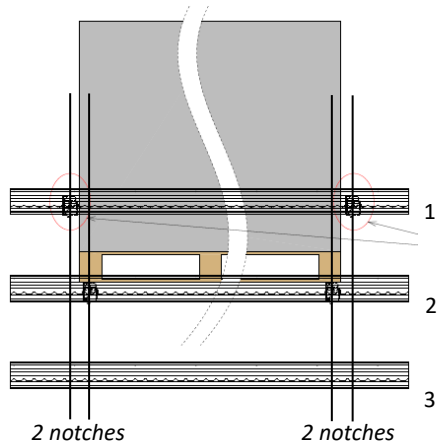

◆ **Positioning / removing a beam from the rail system**

Tools: T30 Torx wrench, 1 x 5mm male wrench and 1 x 6mm male wrench

Procedure:

- 1) The beam retention device is located at the first notch on the upper rail on both sides. Undo the two screws and remove the clamping plate.
- 2) Move the beam up to the retention device and remove the screw from the sliding end (left side).
- 3) Supporting the beam with your hand, tilt it to approximately 45°, so that you can remove the left side roller from the rail and push it in as far as the beam stop.

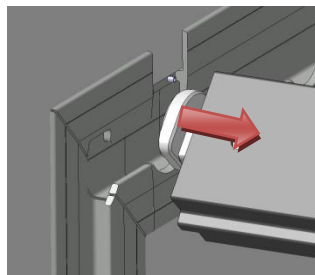
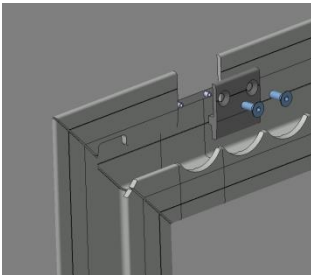

- 4) Once the left end has been removed from the rail, move the beam to the left so that the right end comes free of the rail. (Removal of the end screw on this side is not necessary.)

Reverse the procedure to re-fit the beam in the rail system.

WARNINGS / PRECAUTIONS IN USE



- ◆ Use the Multideck-C system with the vehicle on a horizontal surface and immobilised.
- ◆ Do not exceed the maximum load indicated on the beams.
- ◆ Do not exceed the maximum usable permitted load and comply with current regulations on the distribution of loads within the vehicle.
- ◆ The total load on the upper floor should never exceed the total load on the vehicle floor and should not exceed 2000kg per metre of vehicle length.
- ◆ Follow good practice rules with regard to loading goods on the upper floor. Here are a few examples:

- ➔ Heavier loads on the trailer floor.
- ➔ The tallest loads towards the front.
- ➔ Loads on the upper floor should always be supported front and rear, either with beams or by the rest of the load.
- ➔ The final pallet should always be secured.

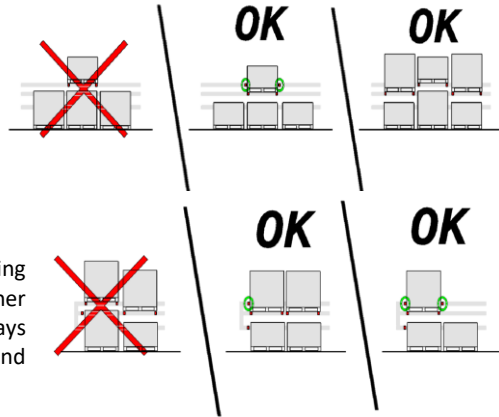

- ◆ Loads on the upper floor must be secured.
- ◆ Beams are the only acceptable method of securing against lengthways movement. Straps and other securing methods are not adequate lengthways restraints, since they are not designed to withstand lengthways stresses (emergency braking, etc.).
- ◆ Beams are not suitable crossways load restraints (incomplete rows, dollies, etc.). In such cases, additional restraints should be used such as straps or stowage bars.
- ◆ Where necessary, replace a damaged beam with a new one with identical technical characteristics to the original. Take care not to trap your fingers when moving several beams at the same time.
- ◆ The Multideck system should only be used by trained personnel. The Chereau Services network is able to offer appropriate training.
- ◆ The Multideck-C system requires the use of poles to move beams in the storage zone. It is recommended that poles are returned to their storage location after each use.



PROHIBITED

- ◆ Do not use mechanical means to store or move beams.
- ◆ Do not walk or sit on beams.
- ◆ Sitting or moving underneath loads is not permitted.
- ◆ Placing loads on beams in the movement position, even several beams pushed together, is not permitted.

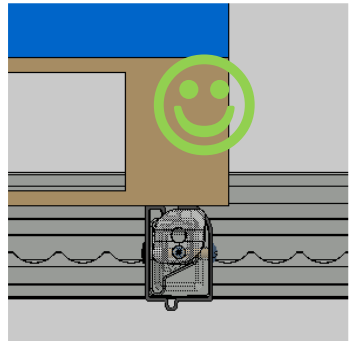
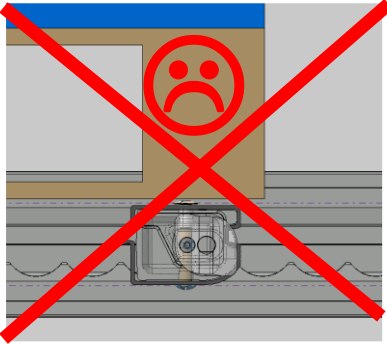

- ◆ Loads must always rest on the whole of the upper surface of a beam.

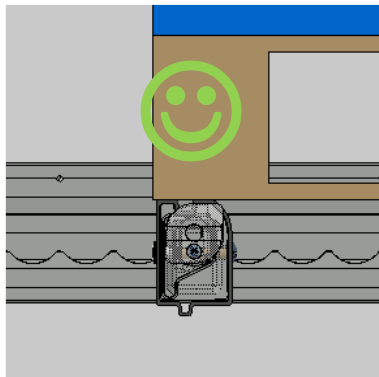
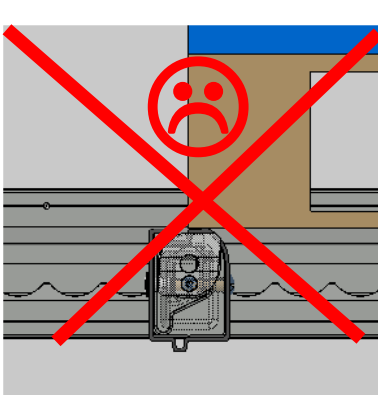

7) Roller curtains

- ◆ Roller curtains limit the heat exchange between the interior and exterior during repeated loading/unloading operations.
- ◆ In order to maximise their efficiency, roller curtains should always be lowered so that they touch the floor along the entire width of the body.

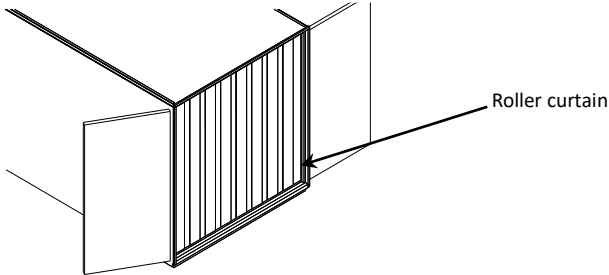

Repair and maintenance

Roller curtains must be regularly washed to maintain a good state of hygiene.

8) Air Shutter-C



- ◆ Air Shutter-C is an automated device for limiting temperature losses between the inside and outside of the vehicle when the doors are open.

Operation

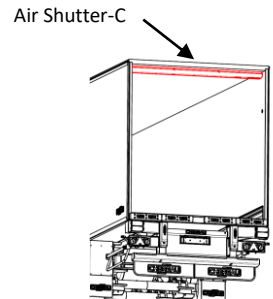
- ◆ For the air curtain to operate at its best, it is essential that the air suction and blowing areas are kept clear.
- ◆ Starting and stopping are automatic:
 - ◆ When the door is opened, the air curtain starts.
 - ◆ When the door is closed, the air curtain stops.
- ◆ The air curtain has a push button on the right hand side of the body, so that it can be stopped or started at any moment.
- ◆ The air curtain is programmed to stop automatically after 30 minutes. A manual re-start is required to re-activate the curtain (new 30-minute cycle).
- ◆ The air curtain stops automatically if the difference between the internal and external temperature is less than 2°C.



◆ Status indicators:

Type of indicator	Indicator status	Meaning
	Green LED on	Air curtain in operation. No known fault
	Orange LED on	Air curtain in operation. Fan fault or temperature sensor fault detected. Curtain requires maintenance: replace the fan or the sensor.
	Red LED on	<ul style="list-style-type: none"> • <u>LED flashing:</u> Air curtain in operation. Risk that the air curtain could shut down to save the battery from a deep discharge. • <u>LED on steady:</u> Air curtain switched off. Supply voltage inadequate. Recharge the batteries.

Servicing and repair

 **Before doing any work, ensure that there is no power to the air curtain. Use the battery cut-off or disconnect the tractor from the trailer.**

 **Refer to the "Maintenance operations" chapter to determine service intervals.**

- ◆ Cleaning: Avoid any prolonged water splashing on to the air curtain and any direct water splashing on to its internal components.
- ◆ Batteries: It is recommended that the power supply to the air curtain is disconnected if the vehicle is not used for more than two weeks.
- ◆ Control sensors:
 - ◆ For the air curtain to operate correctly, it is recommended that the temperature sensors are replaced regularly. Refer to the date printed on a sensor to know when it should be replaced.

- ◆ Sensor measuring the outside air temperature: open the lower cover. The sensor is located on the third fan from the right of the air curtain.

Outside air temperature sensor

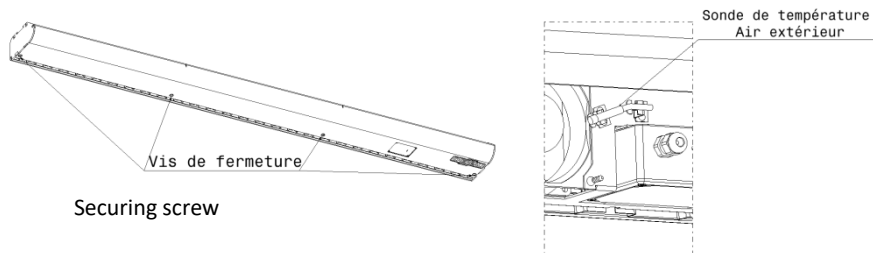

- ◆ Inside air temperature sensor: open the PVC enclosure on the outside of the curtain on the right hand side or on the roof, depending on the type of rear closure.

9) Internal suspension control

- ◆ Vehicles equipped with ECAS functionality with docking autonomy option. A device supplies the EBS with current via a battery connected to the system.
- ◆ The battery is recharged via the EBS while this is supplied via the EBS ISO 7638 lead.
- ◆ ECAS operates for 1 hour (stand-by) after contact deactivated / trailer unhitched. Beyond that time the system automatically switches to sleep mode.
- ◆ To activate ECAS, press the push button on the internal control for less than 5 sec. or the push button on the external control.

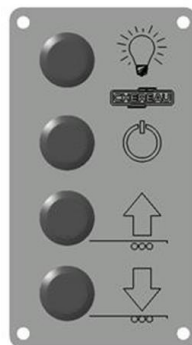

- ◆ Extending the stand-by time: if the push button is pressed again before the stand-by runs out, the time will be doubled. By pushing the button several times, the standby duration is increased to the same extent (maximum of ten times).
- ◆ To de-activate ECAS (change to sleep mode): Hold the push button pressed for more than 5 seconds.
- ◆ Note: To prevent the battery discharging completely, the supply is de-activated when the voltage drops below 22 volts.

Refrigeration unit

The refrigeration unit consists of all elements used to cool the interior of the body.

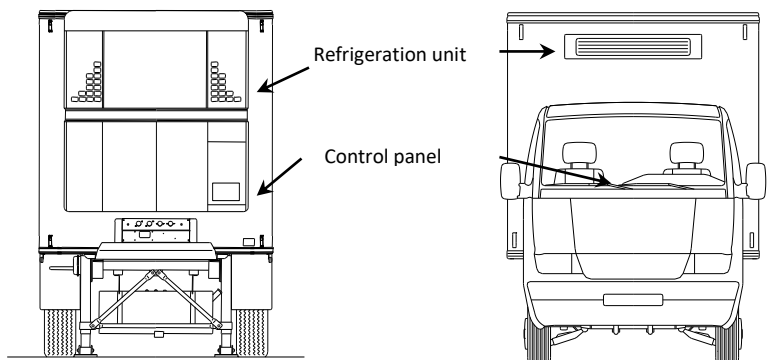

- ◆ The refrigeration unit is used to create and maintain a pre-set temperature in various compartments of the body. This piece of equipment is identified by a data plate attached to it. This plate contains the brand, model, serial number and technical specifications of the machine.
- ◆ The model and serial number of the unit must be quoted in all correspondence.

Operation

- ◆ The desired temperature is achieved by ventilation and cooling of the air which circulates within the body. It is, therefore, important that the air can circulate freely around the cargo (see the chapter on cargo, page 56) without being obstructed in evaporators, ventilation ducts, through air regain or similar.
- ◆ The unit is equipped with its own fuel tank and a visual gauge.
- ◆ The control panel of the refrigeration unit is usually located on the front left face on semi-trailers or in the cabin in trucks.
- ◆ It is important to read the unit operation manual in order to familiarise yourself with all functions and maintenance recommendations.



INNOVATION DRIVES YOU FORWARD

Options

- ◆ The auxiliary controls allow the unit to be operated, for example, from within the body.
- ◆ The temperature indicator reads the temperature in one or more compartments. It is usually placed on the left side of the vehicle front face.
Please refer to the supplier's instructions for operating the temperature indicator.
- ◆ The temperature-logging machine memorises the temperature as read inside the body at regular intervals. This machine can be equipped with one or more sensors. The mode of recalling the memorised readings will depend on the model used.
Please refer to the operation manual for instructions on how to handle the machine.

Repair and maintenance

- ◆ Work on this machine may only be carried out by qualified, skilled professionals.
- ◆ Always follow the maintenance guidelines as indicated in the unit operation manual.

Safety equipment

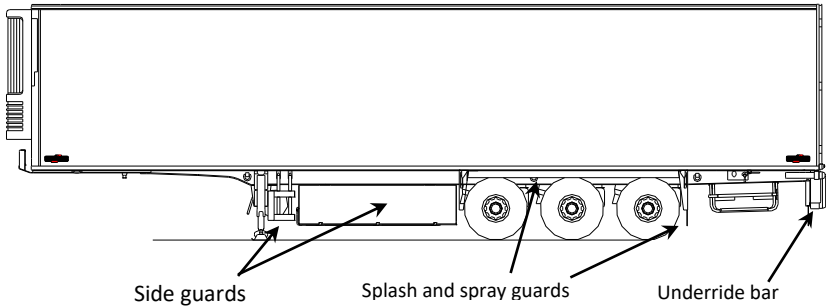

- ◆ To improve road safety, your vehicle is fitted with splash and spray guards, side guards and an underride bar.

👉 All these devices are certified and as such may not be changed or removed.

1) Splash and spray guards

- ◆ The splash and spray guards consist of a special absorbent material with which areas behind and above the wheels are covered.
- ◆ This certified system significantly reduces the spraying of water whilst driving on a wet road.

1) Side guards

- ◆ Side guards are installed under the body with the view to prevent pedestrians, cyclists and motorcycle drivers getting into the space in front of the axle bogie from the side. Tool compartments and palette holders placed under the body are all considered part of the side protection.
- ◆ Certain side guards are removable, to allow access to auxiliary equipment located under the body, such as fire extinguisher, landing gear controls, spare wheel holder or similar.
- ◆ To remove such side guards:
 - Remove the pins located on supports.
 - Remove the assembly.

👉 When finished: replace the side guards properly and secure with safety pins.



INNOVATION DRIVES YOU FORWARD

2) Rear underride bar

- ◆ The rear underride bar is a safety feature designed to protect other road users in the event of collision with your vehicle. This device is subject to certification and may, under no circumstances, be altered or removed.
- ◆ Where an elevating gate is installed at the back of the body, the underride bar may be used as support for such a device, providing that the bar is certified for such use.

☞ **When replacing parts, only use the original grade screws.**

☞ **The rear underride protection bar is an officially approved system and should not be modified without the approval of the underride protection bar manufacturer's technical department.**

Lights and signalling

Electrical circuitry

- ◆ The electrical circuitry supplies power to all lights, interior and exterior, as well as to all electrical instruments.

Repair and maintenance

- ◆ Only qualified, skilled professionals may carry out work on the system.
- ◆ During repair, the model and exact placement of devices concerned, as well as wire diameters and fuse capacity must be observed. Please refer to your body and carrier documentation for full details on electric circuitry.
- ◆ Only bulbs with identical technical specifications and fitting system may be used to replace faulty ones.
- ◆ Always quote the body serial number when ordering spare parts.

1. CityLight

Simple **CityLight**



Double **CityLight**



Description

The **CityLight** is mounted at the rear of the vehicle in the upper part, positioned in continuity with the 3-function light.

It is composed of:

- A 3-function light: stop, space requirement
- An approved scrolling indicator light
- A working light

Simple CityLight	Double CityLight
<p>Scrolling direction indicator (approved)</p> <p>Work light (not approved)</p> <p>Stop and end-outline marker lamp (approved)</p>	<p>Flasher: scrolling on both ramps (not approved)</p> <p>Scrolling direction indicator (approved)</p> <p>Work light (not approved)</p> <p>Stop and end-outline marker lamp (approved)</p>

The activation of the work light and the scrolling on both ramps (Double **CityLight**) is done when the tailgate is activated (not allowed in traffic).

T.I.R. Equipment

- ◆ The T.I.R. option is necessary for transportation under the International Road Transport standard.
This equipment allows the sealing of the cargo by customs.
 - ◆ The compliance certificate issued for T.I.R. approved vehicles must always be carried in the vehicle.
-  **Upon expiry of this certificate, your vehicle must be submitted to the competent authorities of the country in which the vehicle is registered for new certification.**

Identification

- ◆ Every time transportation is carried out in the T.I.R. regime, rectangular T.I.R. plates must be displayed at the front and rear of the vehicle, in the designated places.
- ◆ T.I.R. plates should only be displayed when transportation is being carried out in T.I.R. mode; in all other cases they should either be removed or crossed through diagonally.

Fitting seals

The following places are provided for customs seals:

- Rear and side door handles,

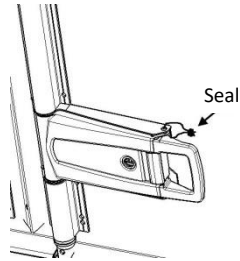

- T.I.R. mounting plates (across the plate, through each eyelet on the mounting nut).

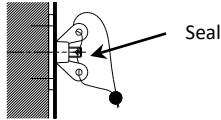

- Mounting tie rods on the refrigeration unit.

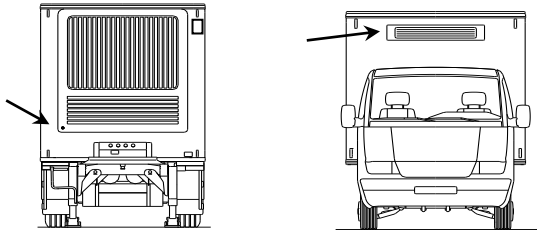

Auxiliary equipment

This chapter provides a non-exhaustive list of auxiliary equipment which may be installed on your vehicle as an option.

1) Tailgate lift

- ◆ The lift is installed at the rear of the body to facilitate the loading and unloading of goods. A technical information booklet and checklist are supplied with the lift and should always be kept in the vehicle.

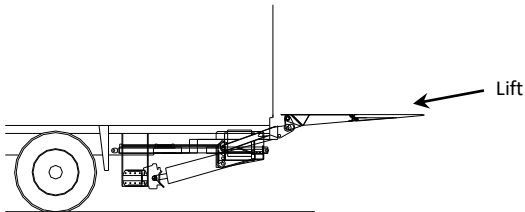

Identification

- ◆ The lift identification plate is situated on the right hand side at the rear of the vehicle.

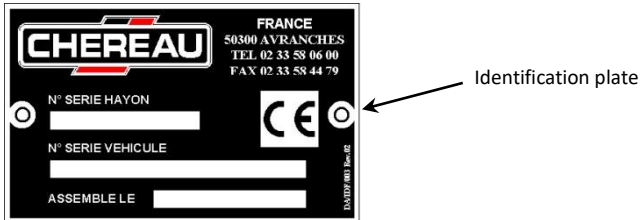

The lift serial number must be quoted in all correspondence.

Operation

- ◆ Before using the lift, please **read the manual carefully**.
- ◆ The control panel is usually placed on the right hand side, at the rear of the body.

Repair and maintenance

- ◆ Only qualified, skilled professionals should carry out work on the lift.

Periodical checks described in the operation manual must be carried out as prescribed.

2) LEVIAND

- ◆ LEVIAND is a piece of equipment, installed at the back of the vehicle, which facilitates the unloading of suspended cargo from inside the vehicle. The instruction and maintenance manual supplied with LEVIAND should always be kept in the vehicle.

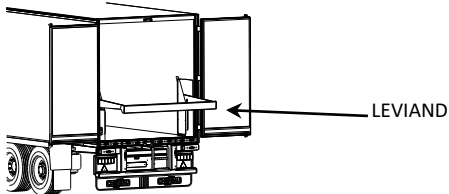

Identification

- ◆ The manufacturer's plate for LEVIAND is situated on the side of the machine's right stand.

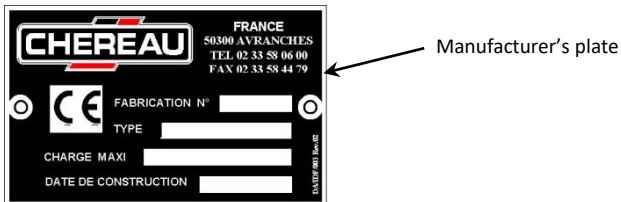

 **The serial number and model of the machine must be quoted in all correspondence.**

Operation

- ◆ Before using the machine please read the manual, particularly the safety guidelines and instructions for use.
- ◆ The control panel is situated inside the body.

Repair and maintenance

- ◆ Only qualified, skilled professionals are permitted to work on LEVIAND.

 **Periodical checks described in the operation manual must be carried out as prescribed.**

3) Pallet holder

- ◆ The pallet holder installed under the body allows unused palettes to be packed away, reducing handling to a minimum.
- ☞ **Pallet holds, regardless of their type, are especially designed to store pallets or in some cases, spare wheels.**

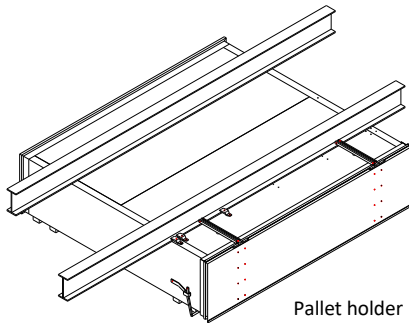

Pallet holder

Operation

- ◆ To open the holder :
 - Where necessary, remove the theft protection.
 - Release the locking mechanism by turning the side handle.
 - Lift the door open.
 - Slide the door above the container.
- ◆ To close, repeat the above operation in reverse order.

4) Wheel holder

- ◆ The wheel holder is situated under the body. It can store one or two spare wheels.

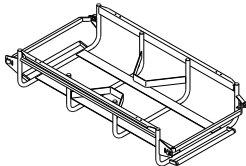
Double basket-type
Wheel holder

- ◆ Depending on the model, access to the wheel holder is either through the back of the vehicle or by the side.

5) Toolbox

- ◆ The toolbox is designed to store tools as well as any other equipment which may be required during transportation.

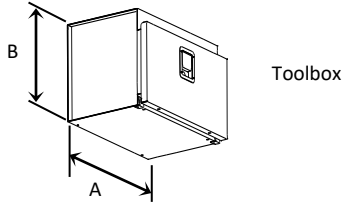

- ◆ To open: pull the door lever to retrieve the toolbox from its casing.

6) Stepladder and ladder

- ◆ The stepladder and the ladder facilitate access to the vehicle. This equipment is fitted with a safety lock and anti-slipping surface on the steps. It is stored either by sliding or by turning under the box.
- ◆ To take the ladder out, unlock and pull out the lodged ladder.
To pack the ladder, push the ladder under the box and ensure that it is locked in place.

7) Fire extinguisher

- ◆ An optional 6kg fire extinguisher is installed on the outside of the body, in a place which is easily accessible by the driver.
This ABC class powder extinguisher is subject to compulsory periodic checks.
- ◆ After each use, even partial, the extinguisher must be refilled.
- ◆ Legal notice: for tractor/semi-trailer combinations, the extinguisher may also be placed on the tractor, outside the cabin, in a place easily accessible by the driver.

8) Central greasing

- ◆ The central greasing system automatically greases all connected equipment such as :
 - Lift joints.
 - Fifth wheel.
 - Axles.The greasing system is powered pneumatically, in parallel with braking.
- The grease level in the greasing system must be checked regularly.
- ◆ When topping up, always use NLGI-0 grease.

9) Rear protection

☞ **The rear protection systems do not remove the necessity for extreme care on the part of the driver when docking.**

- ◆ The rear “CHEREAU bumper” is an optional piece of equipment that effectively protects the rear of the vehicle during docking and loading/unloading. The system is the subject of a registered European patent.

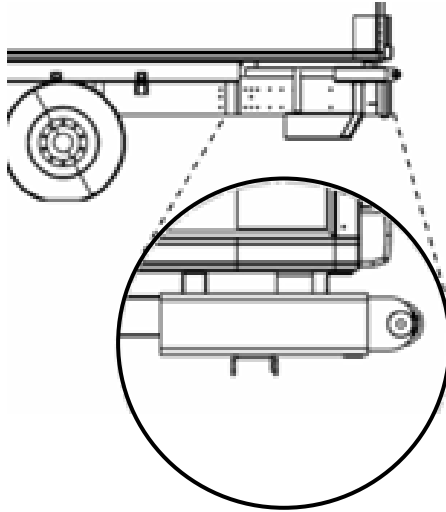

Other vehicles version

- ◆ Rear protection device: as an option, rear protection buffers can be installed on the underride protection bar mountings or on the body loading sill.

ATP Regulations

1) Definition

ATP

- ◆ ATP is an agreement on the international carriage of perishable foodstuffs and on the special equipment to be used for such carriage.
ATP compliance certificates are issued for a limited period of time.

 **Regularly check the expiry date of your ATP compliance certificate.**

Isothermal efficiency

- ◆ Isothermal efficiency is measured using the insulation coefficient "K", calculated on the basis of measurements taken on prototype vehicles in an authorised laboratory.
- ◆ **A vehicle is normally Insulated** if the coefficient K is lower than **0,70 W/m²/°C**.
A vehicle is heavily Insulated if the coefficient K is lower than **0,40 W/m²/°C**.

ATP standards for refrigerated vehicles

- ◆ A refrigerated vehicle is equipped with an isothermal chamber fitted with a refrigeration unit which, at an outside temperature of + 30°C, depending on the standard, is capable of maintaining the interior temperature of an empty chamber at the following temperatures :
 - A Class: the temperature can be set between +12°C and 0°C inclusive.
 - B Class: the temperature can be set between +12°C and -10°C inclusive.
 - C Class: the temperature can be set between +12°C and -20°C inclusive.

2) Marking

- ◆ Example : **FRC**
5-2020 ← Expiry date of the ATP certificate

- ◆ Different markings :
 - Normally-insulated A class vehicle FNA
 - Heavily insulated A class vehicle FRA
 - Heavily insulated B class vehicle FRB
 - Heavily insulated C class vehicle FRC

3) Documents

- ◆ The technical conformity ATP certificate must always be kept in the vehicle.

Noise reduction

Urban deliveries require a reduction in the noise caused by loading and unloading, so as not to disturb local residents. In this respect, vehicles may include special equipment aimed at reducing noise emissions:

- Low noise floor coverings;
- Kick-boards and impact protections made of synthetic material;
- Noise-reduction coatings on tail-lift platforms;
- Automatically opening rear curtains;
- Low noise emission refrigeration unit.

To ensure its effectiveness, all noise reduction equipment must be maintained in good order.

Apart from the equipment itself, noise reduction is based mainly on how it is used and the handling of equipment and accessories. The recommendations below will allow you to reduce noise emissions easily:

1) Handling bulkheads

The inside of body is like an echo chamber. All noise is amplified.

When lifting a bulkhead, hold on to it for as long as possible and release it gently, having allowed a little time for it to slow down

Move the bulkhead gently to limit bearing noise



Hold on to the rising bulkhead and allow it to lock itself into the roof



2) Handling tail-lifts

Deploying the mobile platform on a tail-lift can be one of the main causes of noise nuisance around a vehicle.

A few precautions are necessary when opening and closing it.

Proceed in three steps:

1. Leave at least 10 cm between the platform and the ground.
2. Deploy the platform.
3. Complete the lowering of the platform.



Handle roll stops carefully and regularly check the condition of noise dampers

Hold on to the platform when folding it up and do not let go of it.



3) Handling steps

Ladders and steps will make noise when being opened, if not handled with care.

Pull out ladders and steps gently as far as their stops.



Some ladders reach all the way to the ground. It is recommended that you do not simply allow them to drop to the ground.

Deploy and support ladders and steps at the end of travel and do not let go of them.



Ladders and steps will make noise when being folded away, if not handled with care.

Store ladders and steps by guiding them as far as their stops without banging.



4) Handling doors

When opening a door: If you just let go of a handle, it will bang against its end stop under the effect of the return spring.

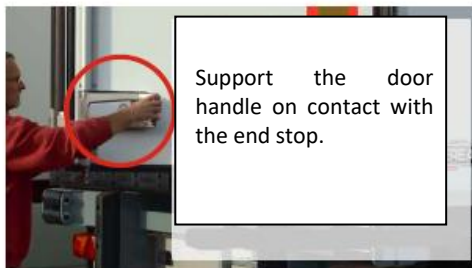

For the same reason and with the same effect, hold the door stay when removing it, to reduce the effect of its return spring.



When closing a door: Position it with the handle open at 90°, taking care not to allow the latch to bang shut.

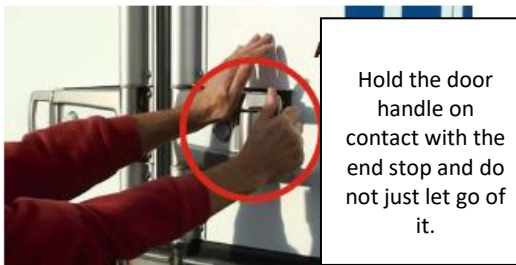

Servicing

1) General

- ◆ Safety procedures carried out prior to each journey are part of daily maintenance.
- ☞ **To keep your vehicle body in good condition, it is essential to follow the maintenance instructions and comply with service intervals.**
- ☞ **All maintenance operations must be carried out by qualified, authorised personnel.**
- ◆ Maintenance instructions given in the user manuals for various equipment on the body must also be followed.
- ◆ For each maintenance operation, refer to the chapter concerned or the appendices for more information.

2) Body and internal equipment

Maintenance operations	Frequency <i>Whichever is reached first</i>		
	3,000 km Every week	30,000 km Every 3 months	90,000 km Every year
Check the condition of all seals around doors and partitions	●		
Check partitions visually	●		
Option: check the level in the centralised greasing unit	●		
Greasing of opening mechanisms		●	
Greasing of hanging rails		●	
Check that locking devices on hanging rails operate correctly		●	
Check that the fixings on stowage rails are in good condition		●	
Check that partitions are properly greased and operate correctly		●	
Clean inside of the air curtain		●	
Check the tightening torque of all clamps and securing screws on the body			●
Check the tightening torque of securing nuts on hanging rails			●

Maintenance operations	Frequency <i>Whichever is reached first</i>		
	3,000 km Every week	30,000 km Every 3 months	90,000 km Every year
Check the tightening torque of securing screws on door hinges			●
Check the validity dates on air curtain temperature sensors and replace them every three years			●
Check the condition of side doors and that they operate correctly: seals, moving parts, bearings, fixings			●

3) Refrigeration unit

 Follow the servicing schedule in the user manual.

4) Auxiliary equipment and lighting

Follow the servicing schedule in the various user manuals.

Maintenance operations	Frequency <i>Whichever is reached first</i>		
	3,000 km Every week	30,000 km 1 month	90,000 km Every year
Check that lighting equipment operates correctly	Before each journey		
Check the tightening torque of securing nuts on auxiliary equipment		●	
Grease auxiliary equipment		●	

5) Multideck-C equipment

Maintenance operations	Frequency <i>Whichever is reached first</i>		
	3,000 km Every week	30,000 km 1 month	90,000 km Every year
Check poles visually and ensure that they work correctly: Check that both beam handling poles are present and that they work correctly	●		
Check poles visually and ensure that they work correctly: Check the tightening of pole, fall-prevention and pole storage screws	●		
Check beams visually and ensure that they work correctly: Check that there is no distortion or sign of impact that could affect their strength	●		
Check rails visually and ensure that they work correctly: Clean dirt from the rail system that could impede or prevent the movement of beams (wood, adhesives, etc.)	●		
Check rails visually and ensure that they work correctly: Check the tightness of connections and that there is no sign of rails coming adrift	●		
Perform a visual and functional check of rear partition stops (beam protection)	●		
Check that rails are not distorted or bent, which could impede the movement or locking of the beams		●	
Check that there are no cracks along the beam profile or signs of impact; replace a beam, if necessary		●	
Check the condition of the guides between the ends and the beam profile (no sticking) If necessary, replace the bearing mechanism on the non-fixed end			●



INNOVATION DRIVES YOU FORWARD

Maintenance operations	Frequency <i>Whichever is reached first</i>		
	3,000 km Every week	30,000 km 1 month	90,000 km Every year
Check the condition of the beam rollers and replace them if there is any sign of cracking, distortion or excessive wear			●
Check the condition of the beam profiles and replace them if there is any obvious residual deflection greater than 5mm or cracking at any point along the profile			●
Check the condition of the beam ends for signs of damage, cracking or anything else that might adversely affect the beam's strength Replace components, where necessary			●
Replace any rail that could prevent the free movement of beams			●
Check that screws on beams are tight (roller fixing screw on the end: medium thread lock)			●
Replace markings that are unreadable or badly damaged			●

Reminder: do not grease or lubricate the rails or the beams.



INNOVATION DRIVES YOU FORWARD

Introduction

- ◆ This manual is designed to help you operate and maintain your CHEREAU vehicle. It should always be kept in your vehicle and read by all users of the vehicle and maintenance staff.
- ◆ The CHEREAU isothermal body is designed for the transportation of goods or products at controlled temperature. All equipment built into the CHEREAU body has been studied in order to achieve the best quality transportation.
- 👉 **Please note that CHEREAU bodies are designed to be used by freight professionals who in turn, have the responsibility to ensure that the vehicle is used in compliance with current local regulations.**
- ◆ In order to ensure the safety of transportation and preserve the quality of goods transported, close application of the guidelines concerning use and maintenance provided in this manual is strongly recommended.
- ◆ CHEREAU reserves the right to make any alterations deemed necessary for improving its products, on its entire product range, without prior notice.
- ◆ Any modification or addition to equipment must be submitted to CHEREAU for prior agreement.

IT/LIV/203.rev03

Identification

- ◆ All CHEREAU bodies are identified by the manufacturer's plate located on the front face of the body. This plate indicates the type and the model of the body as well as the serial number and the date of manufacture.

☞ **The serial number of the body must be quoted in all correspondence.**

- ◆ Manufacturer's plate:

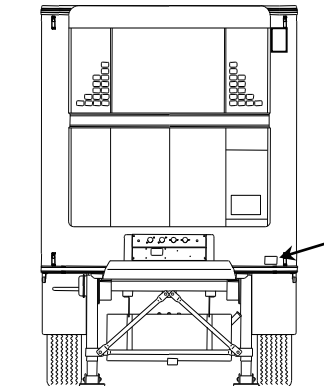

Manufacturer's plate

Safety

1) To be checked before each journey:

- ◆ Ensure that there is no human presence inside the bodywork.
- ◆ That all back and side doors are closed.
- ◆ That the back doors are properly locked and that steps and ladders are correctly secured.
- ◆ That all lights are working properly.
- ◆ That the level of fuel, engine oil and cooling liquid of the refrigeration unit is sufficient.

2) Always keep the following documents in the vehicle:

- ◆ Registration Document
- ◆ Certification of conformity to the ATP - chassis user manual
- ◆ Operation and Servicing manual for the body
- ◆ User's Manual for the refrigeration unit.
- ◆ User's Manual for all auxiliary equipment (tailgate, Leviand...)
- ◆ T.I.R Certificate (optional)

Cleaning

- ◆ Regular cleaning and maintenance are the only way to guarantee a good level of cleanliness and compliance with hygienic requirements in transportation.
- ◆ The locations on the body that are most exposed to dirt are the seals and rails. Special attention should therefore be paid to cleaning all parts of these items.
- ◆ Parts should be washed using non-aggressive products (pH between 5 and 9) and at a temperature below 50°C.
- ◆ The washing lance must be held at least 30cm away from the surface and the pressure should not exceed 60 bars (or 60cm for 180 bars). Do not be too insistent on electrical components (connector, control box, etc.)
- ◆ Rinse thoroughly after washing.
- ◆ The grids protecting the refrigeration unit evaporator must be cleaned regularly using a hand brush. This can only be carried out when the unit is not in operation.

Prohibited cleaning products:

- Abrasive cleaning products,
- Strong alkaline solutions (ammonia, caustic soda, etc.),
- Organic (acetone), chlorinated (trichloroethylene) or aromatic (xylems, toluene) solvents.

Use

6) Temperature inside the body

During loading, both the temperature inside the body and the loading temperature should be equal to that required during transportation.

 **The use of all or part of the body during transport at a positive temperature, following use at a negative temperature, requires equipment inside the body to be defrosted; this should be taken into consideration when using equipment, so as not to damage the merchandise being transported.**

1) Rear doors:

- ◆ Standard models:
 - First open the right door.
 - Fully turn the handle to 90° to release the seal and de-pressurise the interior of the vehicle, thus facilitating opening.
 - Always use the doorstop to maintain the door in the open position (see page 60).
- ◆ For manual roller shutter doors:
 - Unlock the curtain handle.
 - Raise the curtain.
- ◆ For electric and pneumatic roller shutter doors: see their user manuals.
- ◆ It is important to keep the number and duration of openings to a minimum in order to prevent warm and humid air from entering the body.

2) Loading: general rules

- ◆ Always switch off the refrigeration unit during loading.
-  **Only lifting devices with a maximum load of 5 tons may enter the body.**
- ◆ Skidding by lifting devices while operating on the floor is prohibited.
- ◆ When loading, avoid any contact or collision with the sidewalls of the body.
- ◆ Distribute the load in a way that allows **air to circulate freely**. Air must be able to circulate underneath, above and down the sides of the cargo. Air must be able to circulate freely above, below and around the sides of the load. Space must also be left in front of the load, to ensure that return of circulating air is possible (see the diagram below).

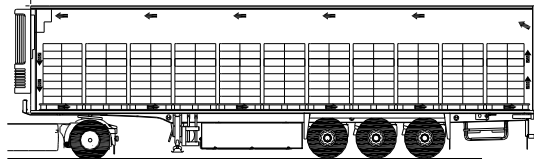

- ☞ **The front side of the body, as well as 15 cm between the top of the cargo and the ceiling.**
- ☞ **When inspecting ventilation ducts, check that the load cannot block the ducts.**

- ◆ The load must be distributed **evenly, along and across the loading area**. Ensure that the maximum load parameters as displayed in the documentation and on the plates of both the tractor and the trailer, are respected:
 - PTR: gross permitted weight of the vehicle.
 - PTC: total permissible loaded weight per vehicle.
 - Bogie weight

- ◆ Loading a body with several compartments:
 - Observe the guidelines for using bulkheads, page 62.
 - Use the available lashing devices.
 - Never use bulkheads to secure cargo.

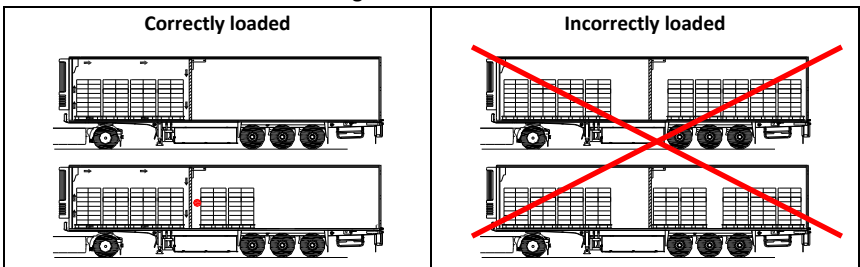

- ☞ **The evaporator inlet and outlet must always be kept unobstructed.**

3) Using the auxiliary equipment

- ◆ The use of certain auxiliary equipment can facilitate loading operations (tailgate, LEVIAND...).
- Do not use this equipment for any tasks other than those for which they were originally designed.
-  **All safety guidelines set out in the operation manual for each machine must be strictly observed.**

4) Lashing the cargo

- ◆ All cargo should be firmly secured in order to prevent it moving during transport.

Eléments d'arrimage

- ◆ Use the lashing points on the body (belt rails, self-tightening grids or ridge girders) to immobilise the cargo and comply with the regulations pertaining to their use. (see pages 66 to 68).
-  **When using lashing straps do not attach them vertically in relation to a sidewall (Please follow the guidelines for the use of belt rails on page 66).**
- ◆ When using ridge girders, ensure that the elevated load is securely fastened.

Hanging systems

- ◆ When using hanging rails, check that bolts are properly closed and that hanging loads are properly stowed.
- ◆ Before shutting the doors, ensure that the ends of rails are blocked to avoid the goods falling when the doors are opened.

5) Closing the doors

- ◆ Before closing the doors, ensure that the space between the closed doors and the cargo will be sufficient to secure the free circulation of air (minimum 6 – 8 cm).
- ◆ Close the doors and bolt the handles.

6) Cargo temperature

- ◆ Once loading is completed and doors firmly closed, set the refrigeration unit thermostat to the requested temperature and switch on the unit. (Please refer to the Refrigeration Unit Operation Manual).

Isothermal chamber

- ◆ The quality of the thermal insulation and an excellent mechanical structure are the two main characteristics of the isothermal chamber. Advanced performance in these two areas is secured through the use of special materials produced using technologies specifically designed for this application.

1) Structure

- ◆ The isothermal chamber consists of rigid, single panels bound together with a continuous mechanical and chemical linkage, assuring perfect homogeneity of the structure and excellent continuity in thermal insulation.

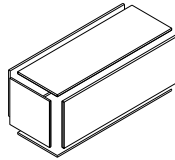

- ◆ Each panel is fabricated using a “sandwich” structure bonding the exterior walls to the insulating foam. This structure was developed with a view to achieving and maintaining optimum mechanical qualities while providing excellent insulating properties.

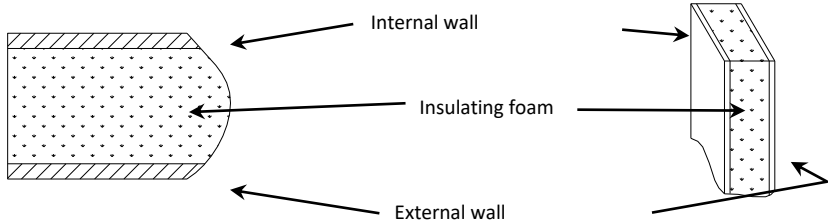

2) Thermal efficiency

- ◆ Isothermal efficiency is measured using the overall coefficient of heat transfer " K ", calculated on the basis of the measurements taken on prototype vehicles in an authorised laboratory. This coefficient guarantees the given degree of insulation quality and is used to determine the refrigerating power which a unit needs to deliver.
- ◆ The lower the coefficient, the better the insulation and the lower the refrigerating power needed to maintain the interior temperature. This is why particular care is taken when designing and manufacturing your vehicle body in a continuous effort to improve its overall coefficient of heat transfer.
- ◆ Radiation causes the heating of bodies exposed to sunlight, resulting in excess consumption by the refrigeration unit. To limit the effect of this radiation, the base colour chosen for the body was white, giving it an excellent reflective quality. We do not recommend the use of dark coatings on the body, as this would impair performance.

3) Coatings and protection

Coatings

- ◆ The interior wall coating consists of layers of glass-polyester laminate (with an optional stainless steel skin).
- ◆ The floor is coated to reduce wear. This is done either by applying an anti-slip coat of polyester resin with glass fabric, or aluminium coating with integrated anti-slip surface.

Protection

- ◆ The most commonly used areas are protected by additional features such skirting and frontal surface protectors (optional).

4) Openings

Rear doors and side openings

- ◆ CHEREAU bodies are equipped with stopping devices which must be used when loading or unloading to ensure alignment of the open doors with the side.

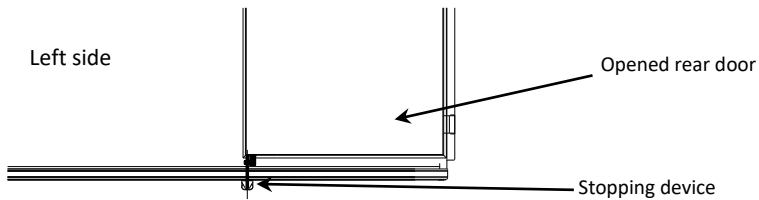

- ◆ Door open sensors

The door opening system may be equipped with an optional sensor to control the various equipment. The sensor is situated on the upper latch. It can be accessed by removing the rear running light support.

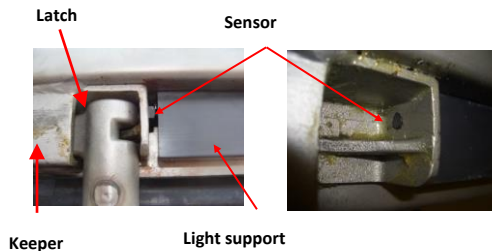

Isothermal roller

For the use and maintenance of isothermal roller shutter doors, see the specific manual supplied.



INNOVATION DRIVES YOU FORWARD

5) Repair and maintenance

- ◆ In order to preserve the original quality and performance of your isothermal chamber, all its components must be kept in good working order and the following rules observed:
 - Monitor the tightness of the doors and keep the seals in good condition. Replace the seals as soon as this is necessary.
 - Immediately organise repair of the body if any of the sidewalls is punctured as a result of an impact, in order to avoid the infiltration of humidity which could reduce the vehicle's thermal efficiency.
 - ◆ All servicing work must be carried out by qualified, skilled professionals.
-  **The insulation qualities of the chamber can only be maintained if all sealing elements are in good condition.**
- ◆ In order to maintain the original specifications, all repair and maintenance works must be carried out in the proper manner.
- Please contact our customer services for all repair and maintenance work:

JEAN CHEREAU SAS

ZI le Domaine – 50220 DUCEY-LES-CHERIS

FRANCE

Tél: +33 (0) 233.893.893

E-mail: support@chereau.com

Internal equipment

- ◆ This chapter provides a non-exhaustive account of auxiliary equipment which may be installed on your vehicle as an option, as well as corresponding operating instructions.

1) Bulkheads

Bulkheads are used to divide cargo areas into several compartments.

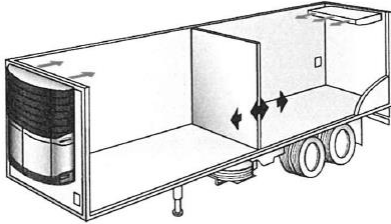

- ☞ **Remember: Never use bulkheads to secure cargo.**
- ☞ **In order to protect the bulkhead elements, two red safety stops limit the angle between the bulkhead and the roof to 90°. If this angle is exceeded, the screws fail and the stops fall. If this occurs, check the condition of the bulkhead and replace the stop screws.**

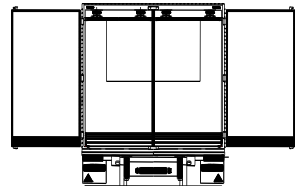
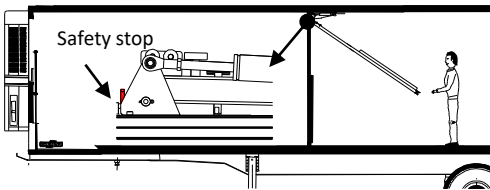

- ☞ **The use of handling equipment to lift bulkheads is strictly prohibited.**

Operating a mobile bulkhead

- ◆ To move a bulkhead:
 - First pull the vertical blue strap to unlock it and then lower the partition to within reach.
 - Lower the bulkhead to mid-height, using the lower part of the handle.
 - Move the bulkhead to the desired position.
 - Lower the bulkhead.
 - Push the handle back in against the bulkhead, and close the decompression flap (where fitted).

- ◆ To lift a bulkhead to the ceiling:
 - Pull the handle towards you.
 - Release the handle once the bulkhead is at mid height.
 - Pull the partition down by hand, holding on to the storage handle until it is fully locked in place. Check that it is locked in place by pulling gently on the handle
 - ◆ Distance in relation to the refrigeration unit in the vertical position, comply with the positions shown on the side walls inside the vehicle.
-  **Be careful not to knock against the bulkhead during loading, as this might cause damage.**

Repair and maintenance

It is very important to keep both the bulkhead and its seals in good condition in order to secure perfect insulation between different compartments.

- ◆ Visual check:
 - Condition of the seals.
 - Condition and presence of U-shape spacers at the base of the bulkhead.

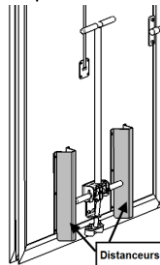

- Condition of the rails and fixings, replace rivets that are not secure and the rail, if distorted.
- Condition of panels (holes, distortion, etc.)
- Condition of rubber end stops (ends of rails)
- Condition of brakes

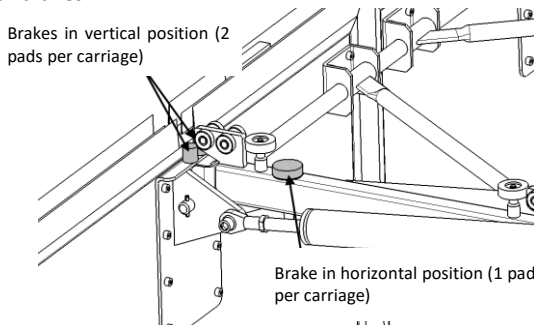

- Presence of bulkhead corner stops

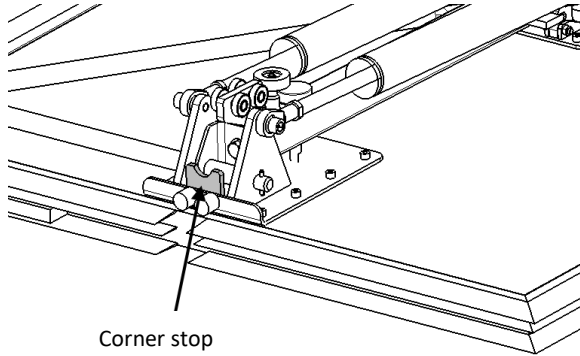

◆ Functional test:

- Locking into the roof
- Locking using the manoeuvring handle (foot, mechanism)
- Longitudinal movement of the bulkhead (bearings)
- Lifting mechanism:
 - d) Position the bulkhead in the centre of the body
 - e) Make an angle in relation to the roof:
 - 45° for gas cylinder bulkheads
 - 25° for spring cylinder bulkheads
 - f) Release the bulkhead
 - If locking occurs spontaneously, the cylinders are correct (repeat the operation three times)
 - If locking does not occur, check the alignment of the carriages and the condition of the entire lifting mechanism.
 - If necessary, adjust the cylinder pre-stressing screw.

◆ Lubrication:

Lubricate the lifting joint, the bolt and the locking finger on the carriage with food-grade grease.

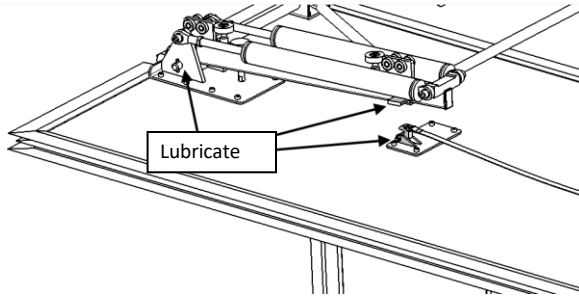

◆ Dismantling the bulkhead::

To remove the bulkhead from the rail, it is recommended that you remove the rail at a connection point.

- Remove the first three fixing rivets from the rail starting from the connection.
- Place a wedge between the roof and the rail, to keep it bent.
- Place another wedge of sufficient thickness between the carriage and the bulkhead panel, to release the horizontal brake completely.
- Make arrangement to take the weight of the bulkhead, once it is freed from the rails (pile of pallets, board lifter, etc.).

☞ **Warning: Weight over 150 kg.**

- Roll the bulkhead towards the freed connection to remove the carriage from the rail.

☞ **If the vehicle is covered by ATP conformity, the bulkheads must not be modified.**

2) Meat hanging systems

- ◆ The meat hanging system allows suspended meat to be transported. A specially reinforced part of the roof is used to support the suspended weight.

☞ **Suspension systems should never be fitted to vehicles not designed for such use.**

- ◆ There are 3 types of system :

- Tubular single-rail system,
- Sliding system,
- Dual-rail system.

☞ **Only hooks designed for a specific system may be used.**

☞ **Tubular single-rail system**

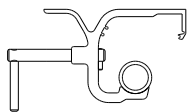

Unbolted bracket

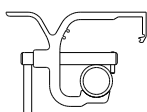

Bolted bracket

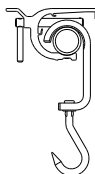

Bracket with hook

☞ **Sliding system**

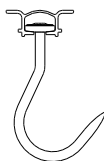
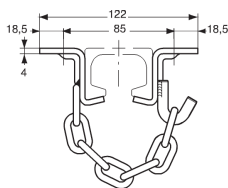

Slide with suitable hook

☞ **Dual-rail system**

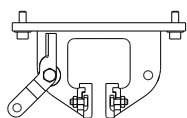

Unbolted bracket

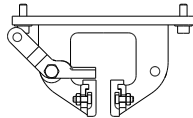

Bolted bracket

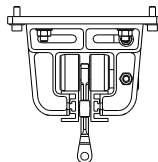

Bracket with hook

☞ **Maintenance**

Only elements with identical specifications may be used to replace hanging elements.

3) Lashing rails

Rows of rails attached to the sides and/or the ceiling and floor of the vehicle are designed to facilitate placement and lashing of the cargo.

Rows of rails can either be flush or raised.

Lashing rail for straps and beams

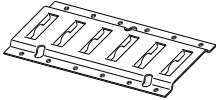

- ◆ Used with straps :
 - Place the strap over the cargo..
 - Tighten the strap.

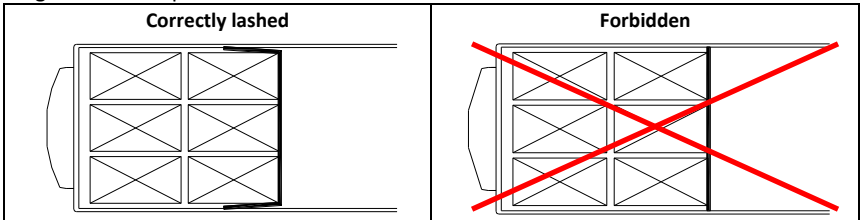

Lashing rail for bars or beams

Lashing bars and beams are only designed for lashing. They should never be used as

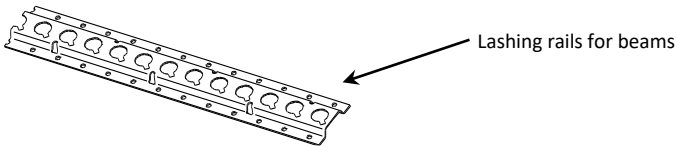

intermediate floor support.

- ◆ Use:
 - Place the bar or beam next to the cargo to be lashed.
 - Unlock one side of the bar or beam.
 - Place the bar or the beam onto the rail.
 - Lock that end.
 - Repeat the same operation with the other end.

4) Self-tightening grids

- ◆ Self-tightening grids are used to maintain the cargo in its position.

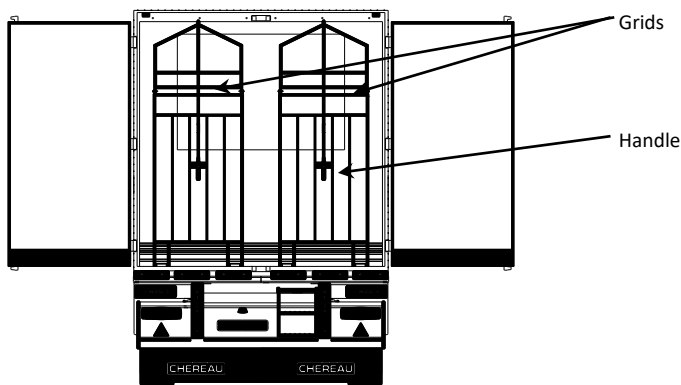

- ◆ Self-tightening grids are adapted to the dimensions of each body; consequently they may not be used with another vehicle.
- ◆ Operation :
The grids are mounted on the ceiling, on a guide or on a rail.
To move the grid:
 - Unlock the grid.
 - Slide the grid or take it out of the rail.
 - Place the bottom of the grid against the cargo to be fixed and keep in that position using your foot.
 - Sliding the grid, place its top end into the corresponding guide rail so that its position is fully vertical.
 - Lock the grid.

Repair and maintenance

- ◆ It is important to maintain the grid caps in good condition to avoid damaging the chamber coating.
- 👉 **Only an identical grid may be used to replace another one (please indicate the body serial number when ordering replacements).**
- 👉 **It must be possible to lock the grid without using a great deal of effort. If the amount of effort required to lock the grid ever seems abnormally high, this means that the grid is not meant for that vehicle.**

5) Intermediate flooring

Intermediate flooring is an option which allows the cargo to be placed on two different levels. The system consists of two transverse beams mounted on vertical rail supports.

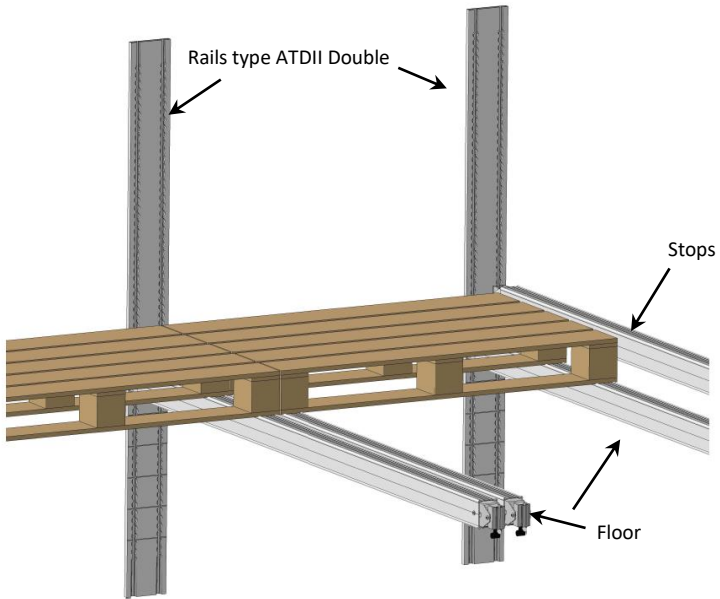

Operation

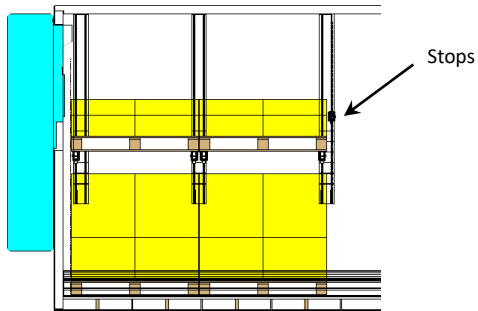

- ☞ Never adjust the height of a beam, while you are underneath it.
- ☞ Always comply with the maximum loading indicated on the beam.

- ◆ To modify the height of a beam :
 - Unlock both ends of the beam with the pole stored in the back of the vehicle.
 - Slide the beam to the desired height.
 - Ensure that the beam is completely horizontal.
 - Lock the ends of the beam.
 - Ensure that the beam forms a horizontal floor with its counterpart.
 - Store the cam in the rail on the right as you enter the vehicle.

- ◆ To stow the cargo :

Secure the cargo by placing a horizontal beam in front of it.

Repair and maintenance

- ◆ Always use only a beam with identical specifications to replace another one.

6) Multideck-C

Description:

MultiDeck-C is a rail and beam system which makes it possible to stow a load at two heights, and also to secure it horizontally.

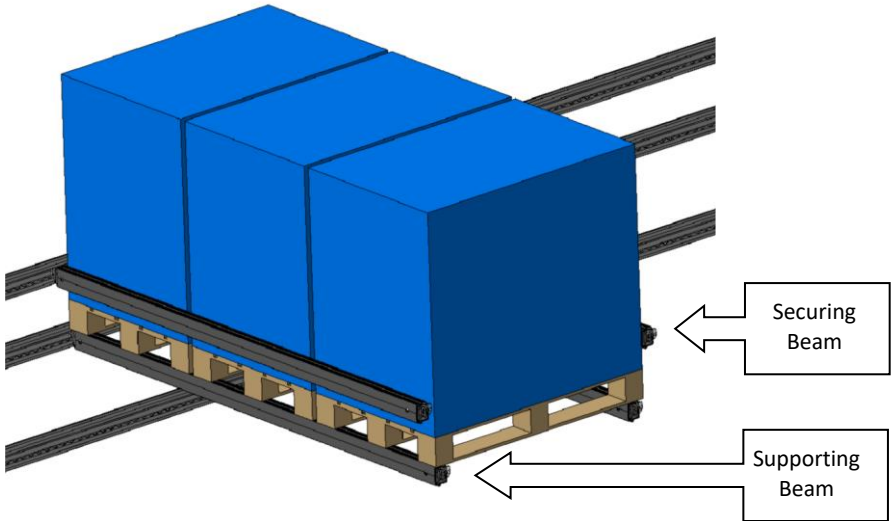

MultiDeck-C beams are captive and slide in a system of rails.

MultiDeck-C beams can be arranged as desired to carry or secure loads in the service rails zone (in black below) and then stored in a special storage zone at the rear of the vehicle (in blue below) when not in use.

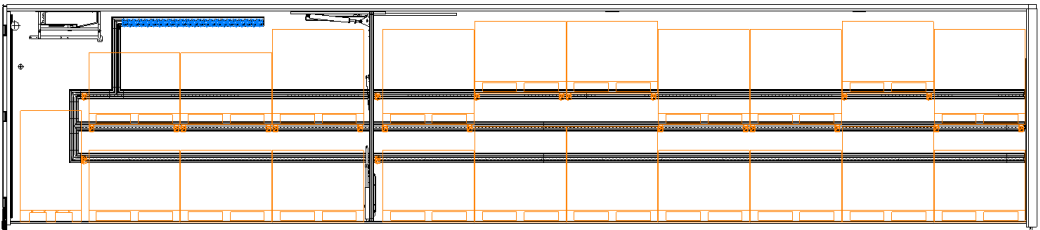

Refer to the user instructions, displayed at the rear of the vehicle, each time that the system is used.

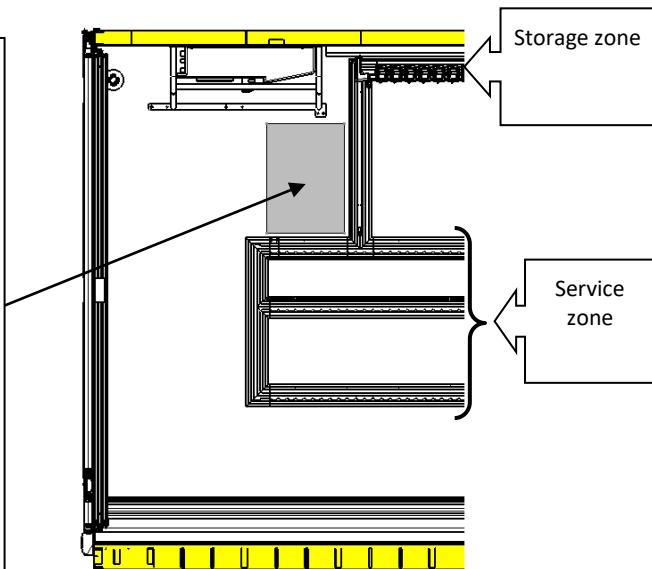
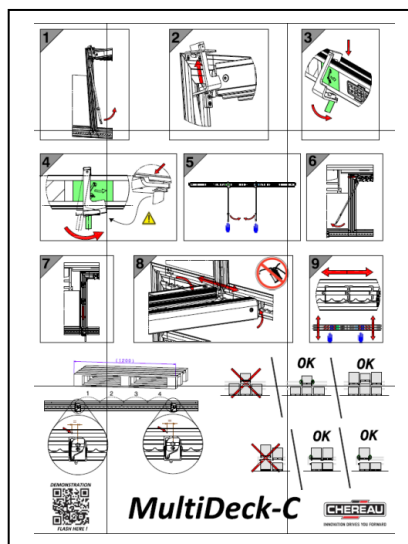

- ◆ Beams slide in the rails when in the horizontal position (1), and are locked in the longitudinal axis when vertical (2).

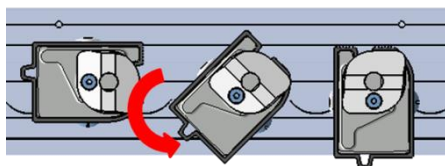

Instructions for use:

◆ **Pole storage**

IMPORTANT: the poles are not identical; there is a right-hand pole (blue marking) and a left-hand pole (green marking), stored on the right and left sides of the body respectively.

1) Removing the poles from their respective storage positions. Pull the handle out at an angle to remove it from the vertical rail.

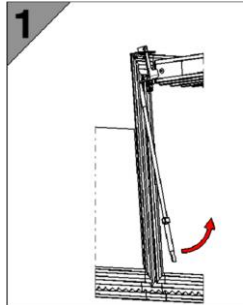

2) Gently lift the poles, so that they are released from their position, hooked over the upper rail.

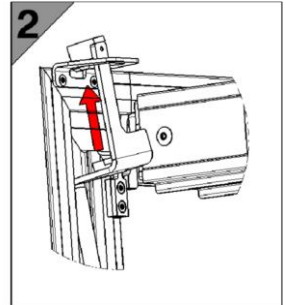

◆ **Handling the beams**

3) Fit the poles into the groove in the top of the beam and push them against the rear-face surface of the beam, taking care to position the poles in the colour-coded areas.

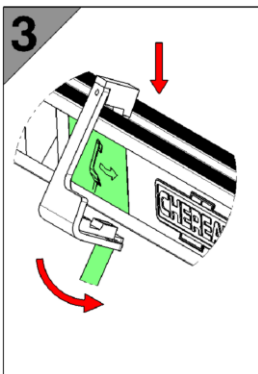

LEFT pole attachment zone

RIGHT pole attachment zone

- 4) Lock the poles by angling the handle inwards, ensuring that the bottom of the hook part of the pole locates against the lower rib of the beam.

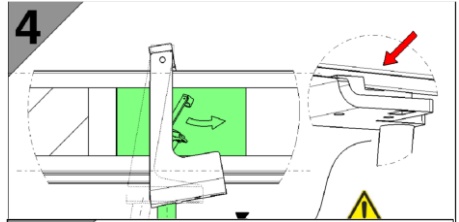

- ◆ 5) **IMPORTANT: hold the poles locked (in the vertical position) to move the beams.**

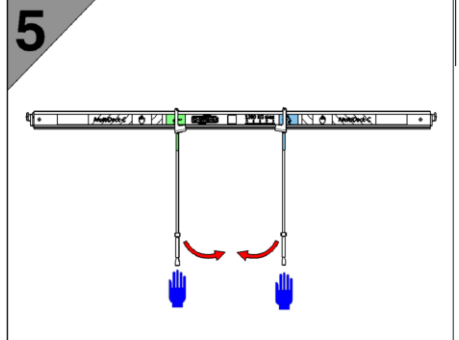

- 6) Tilt the beam slightly and pull it towards the rear, so that it passes over the "fall prevention" device on the upper rail.

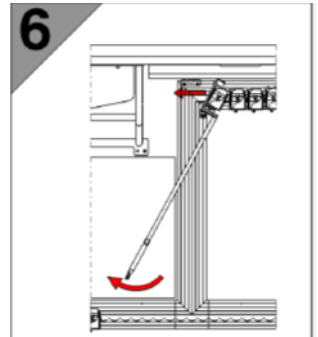

- 7) Once it reaches the stop on the vertical rail, return the beam to the vertical position and lower it carefully on to the horizontal rail. Remove the poles from the beam. Repeat the operation until the required number of beams has been lowered. Replace the poles in their respective storage positions, once the operation is complete.

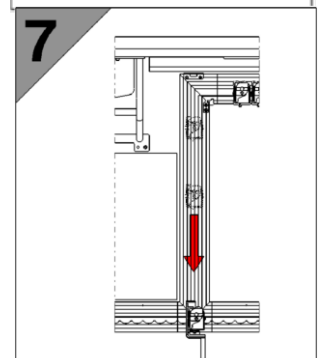

8) Rotate the beam a quarter turn by hand and slide it along the rail system to the desired position.

Return the beam to the vertical, locating it in a notch to lock it in position.

Do not lubricate the rails or beams.

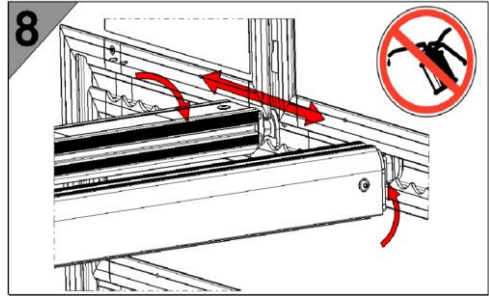

N.B: Beams may be pushed together and moved in pairs.

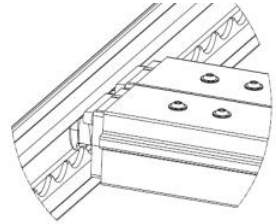

◆ Loading recommendations

➤ Beam position references

There are references on the upper part of the horizontal rails.

N.B: A 1200 x 800mm pallet requires a spacing of five references. Use spacing *X* to find the reference for each beam position.

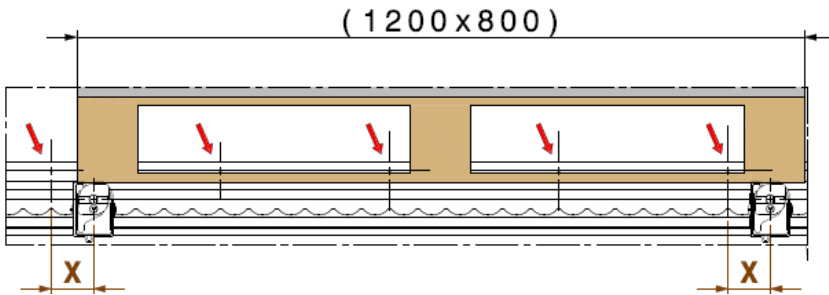
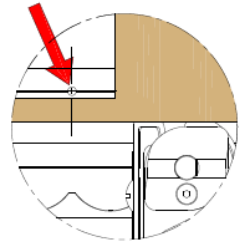

➤ **Load securing**

Single pallets, and also the first and last pallets in "double-floor" operation, cannot be on level 1, if they are to be secured.

➤ **Recommended spacing for securing beams**

The spacing between a "double-floor" beam and a securing beam is two notches.

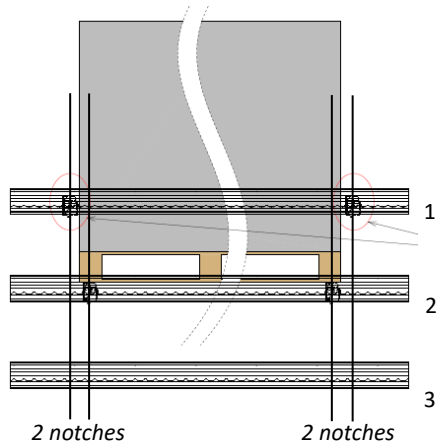

◆ **Positioning / removing a beam from the rail system**

Tools: T30 Torx wrench, 1 x 5mm male wrench and 1 x 6mm male wrench

Procedure:

- 1) The beam retention device is located at the first notch on the upper rail on both sides. Undo the two screws and remove the clamping plate.
- 2) Move the beam up to the retention device and remove the screw from the sliding end (left side).
- 3) Supporting the beam with your hand, tilt it to approximately 45°, so that you can remove the left side roller from the rail and push it in as far as the beam stop.

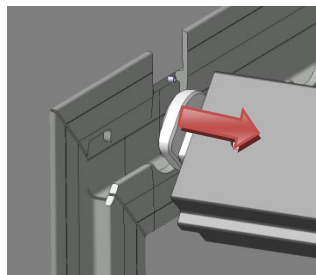
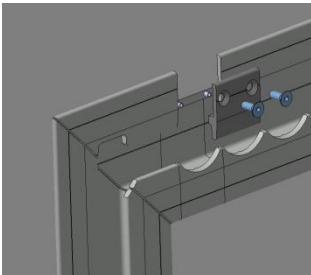

- 4) Once the left end has been removed from the rail, move the beam to the left so that the right end comes free of the rail. (Removal of the end screw on this side is not necessary.)

Reverse the procedure to re-fit the beam in the rail system.



WARNINGS / PRECAUTIONS IN USE

- ◆ Use the **MultiDeck-C** system with the vehicle on a horizontal surface and immobilised.
- ◆ Do not exceed the maximum load indicated on the beams.
- ◆ Do not exceed the maximum usable permitted load and comply with current regulations on the distribution of loads within the vehicle.
- ◆ The total load on the upper floor should never exceed the total load on the vehicle floor and should not exceed 2000kg per metre of vehicle length.
- ◆ Follow good practice rules with regard to loading goods on the upper floor. Here are a few examples:

- ➔ Heavier loads on the trailer floor.
- ➔ The tallest loads towards the front.
- ➔ Loads on the upper floor should always be supported front and rear, either with beams or by the rest of the load.
- ➔ The final pallet should always be secured.

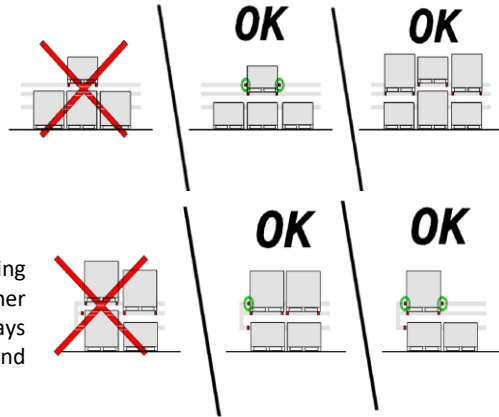

- ◆ Loads on the upper floor must be secured.
- ◆ Beams are the only acceptable method of securing against lengthways movement. Straps and other securing methods are not adequate lengthways restraints, since they are not designed to withstand lengthways stresses (emergency braking, etc.).
- ◆ Beams are not suitable crossways load restraints (incomplete rows, dollies, etc.). In such cases, additional restraints should be used such as straps or stowage bars.
- ◆ Where necessary, replace a damaged beam with a new one with identical technical characteristics to the original. Take care not to trap your fingers when moving several beams at the same time.
- ◆ The **MultiDeck-C** system should only be used by trained personnel. The CHEREAU Services network is able to offer appropriate training.
- ◆ The **MultiDeck-C** system requires the use of poles to move beams in the storage zone. It is recommended that poles are returned to their storage location after each use.



PROHIBITED

- ◆ Do not use mechanical means to store or move beams.
- ◆ Do not walk or sit on beams.
- ◆ Sitting or moving underneath loads is not permitted.
- ◆ Placing loads on beams in the movement position, even several beams pushed together, is not permitted.

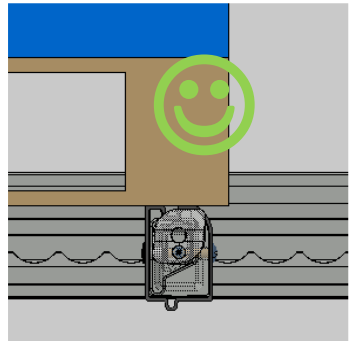
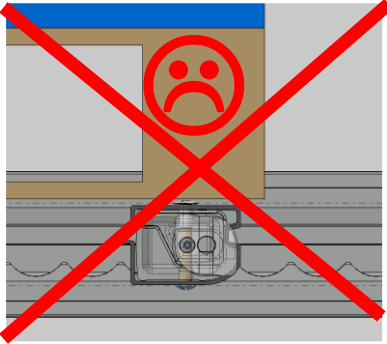

- ◆ Loads must always rest on the whole of the upper surface of a beam.

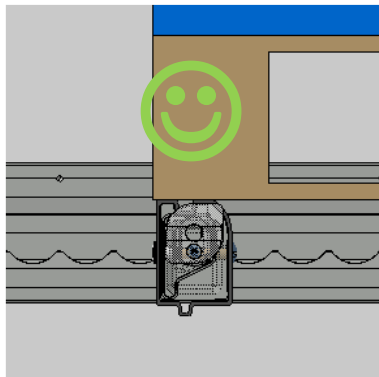
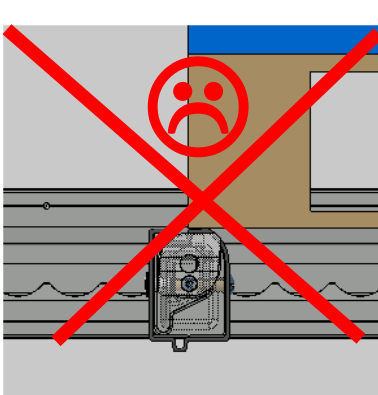

7) Roller curtains

- ◆ Roller curtains limit the heat exchange between the interior and exterior during repeated loading/unloading operations.
- ◆ In order to maximise their efficiency, roller curtains should always be lowered so that they touch the floor along the entire width of the body.

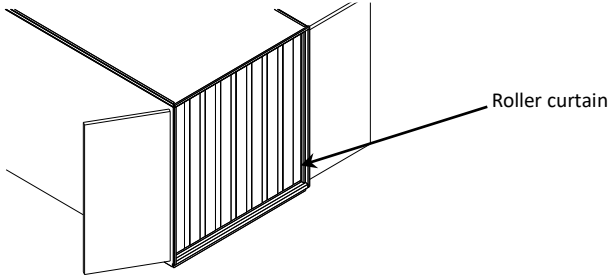

Repair and maintenance

Roller curtains must be regularly washed to maintain a good state of hygiene.

8) AirShutter-C



- ◆ Air Shutter-C is an automated device for limiting temperature losses between the inside and outside of the vehicle when the doors are open.

Operation

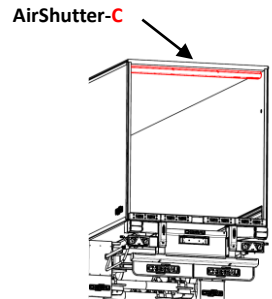
- ◆ For the air curtain to operate at its best, it is essential that the air suction and blowing areas are kept clear.
- ◆ Starting and stopping are automatic:
 - ◆ When the door is opened, the air curtain starts.
 - ◆ When the door is closed, the air curtain stops.
- ◆ The air curtain has a push button on the right hand side of the body, so that it can be stopped or started at any moment.
- ◆ The air curtain is programmed to stop automatically after 30 minutes. A manual re-start is required to re-activate the curtain (new 30-minute cycle).
- ◆ The air curtain stops automatically if the difference between the internal and external temperature is less than 2°C.



◆ Status indicators:

Type of indicator	Indicator status	Meaning
	Green LED on	Air curtain in operation. No known fault
	Orange LED on	Air curtain in operation. Fan fault or temperature sensor fault detected. Curtain requires maintenance: replace the fan or the sensor.
	Red LED on	<ul style="list-style-type: none"> • <u>LED flashing:</u> Air curtain in operation. Risk that the air curtain could shut down to save the battery from a deep discharge. • <u>LED on steady:</u> Air curtain switched off. Supply voltage inadequate. Recharge the batteries.

Servicing and repair

 **Before doing any work, ensure that there is no power to the air curtain. Use the battery cut-off or disconnect the tractor from the trailer.**

 **Refer to the "Maintenance operations" chapter to determine service intervals.**

- ◆ Cleaning: Avoid any prolonged water splashing on to the air curtain and any direct water splashing on to its internal components.
- ◆ Batteries: It is recommended that the power supply to the air curtain is disconnected if the vehicle is not used for more than two weeks.
- ◆ Control sensors:
 - ◆ For the air curtain to operate correctly, it is recommended that the temperature sensors are replaced regularly. Refer to the date printed on a sensor to know when it should be replaced.

- ◆ Sensor measuring the outside air temperature: open the lower cover. The sensor is located on the third fan from the right of the air curtain.

Outside air temperature sensor

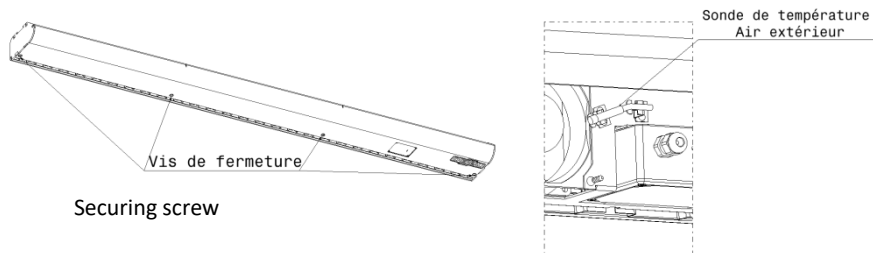

- ◆ Inside air temperature sensor: open the PVC enclosure on the outside of the curtain on the right hand side or on the roof, depending on the type of rear closure.

9) Internal suspension control

- ◆ Vehicles equipped with ECAS functionality with docking autonomy option. A device supplies the EBS with current via a battery connected to the system.
- ◆ The battery is recharged via the EBS while this is supplied via the EBS ISO 7638 lead.
- ◆ ECAS operates for 1 hour (stand-by) after contact deactivated / trailer unhitched. Beyond that time the system automatically switches to sleep mode.
- ◆ To activate ECAS, press the push button on the internal control for less than 5 sec. or the push button on the external control.

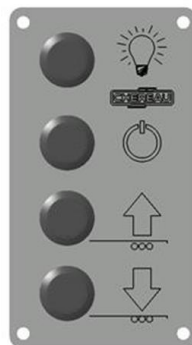

- ◆ Extending the stand-by time: if the push button is pressed again before the stand-by runs out, the time will be doubled. By pushing the button several times, the standby duration is increased to the same extent (maximum of ten times).
- ◆ To de-activate ECAS (change to sleep mode): Hold the push button pressed for more than 5 seconds.
- ◆ Note: To prevent the battery discharging completely, the supply is de-activated when the voltage drops below 22 volts.

Refrigeration unit

The refrigeration unit consists of all elements used to cool the interior of the body.

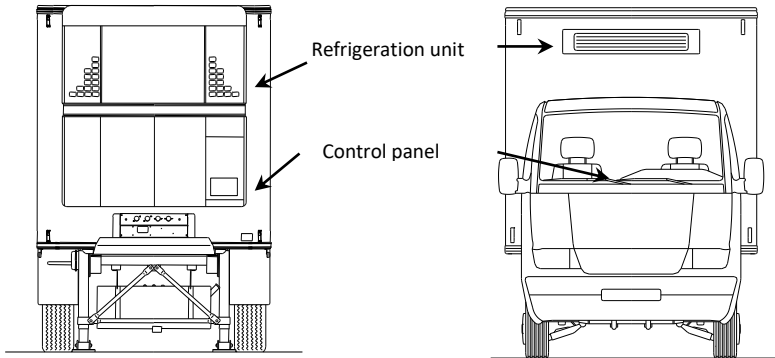

- ◆ The refrigeration unit is used to create and maintain a pre-set temperature in various compartments of the body. This piece of equipment is identified by a data plate attached to it. This plate contains the brand, model, serial number and technical specifications of the machine.
- ◆ The model and serial number of the unit must be quoted in all correspondence.

Operation

- ◆ The desired temperature is achieved by ventilation and cooling of the air which circulates within the body. It is, therefore, important that the air can circulate freely around the cargo (see the chapter on cargo, page 56) without being obstructed in evaporators, ventilation ducts, through air regain or similar.
- ◆ The unit is equipped with its own fuel tank and a visual gauge.
- ◆ The control panel of the refrigeration unit is usually located on the front left face on semi-trailers or in the cabin in trucks.
- ◆ It is important to read the unit operation manual in order to familiarise yourself with all functions and maintenance recommendations.



INNOVATION DRIVES YOU FORWARD

Options

- ◆ The auxiliary controls allow the unit to be operated, for example, from within the body.
- ◆ The temperature indicator reads the temperature in one or more compartments. It is usually placed on the left side of the vehicle front face.
Please refer to the supplier's instructions for operating the temperature indicator.
- ◆ The temperature-logging machine memorises the temperature as read inside the body at regular intervals. This machine can be equipped with one or more sensors. The mode of recalling the memorised readings will depend on the model used.
Please refer to the operation manual for instructions on how to handle the machine.

Repair and maintenance

- ◆ Work on this machine may only be carried out by qualified, skilled professionals.
- ◆ Always follow the maintenance guidelines as indicated in the unit operation manual.

Safety equipment

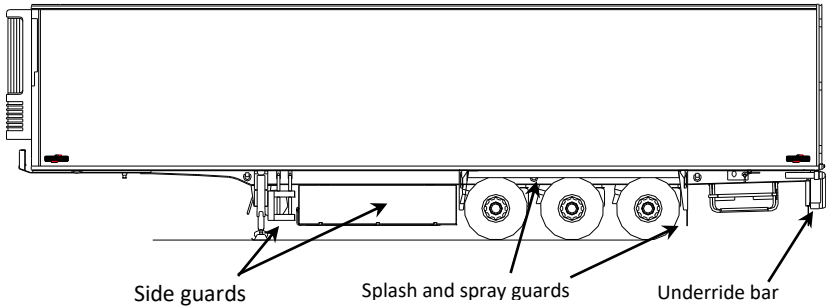

- ◆ To improve road safety, your vehicle is fitted with splash and spray guards, side guards and an underride bar.

☞ **All these devices are certified and as such may not be changed or removed.**

1) Splash and spray guards

- ◆ The splash and spray guards consist of a special absorbent material with which areas behind and above the wheels are covered.
- ◆ This certified system significantly reduces the spraying of water whilst driving on a wet road.

2) Side guards

- ◆ Side guards are installed under the body with the view to prevent pedestrians, cyclists and motorcycle drivers getting into the space in front of the axle bogie from the side. Tool compartments and palette holders placed under the body are all considered part of the side protection.
- ◆ Certain side guards are removable, to allow access to auxiliary equipment located under the body, such as fire extinguisher, landing gear controls, spare wheel holder or similar.
- ◆ To remove such side guards:
 - Remove the pins located on supports.
 - Remove the assembly.

☞ **When finished: replace the side guards properly and secure with safety pins.**



INNOVATION DRIVES YOU FORWARD

3) Rear underride bar

- ◆ The rear underride bar is a safety feature designed to protect other road users in the event of collision with your vehicle. This device is subject to certification and may, under no circumstances, be altered or removed.
- ◆ Where an elevating gate is installed at the back of the body, the underride bar may be used as support for such a device, providing that the bar is certified for such use.

☞ **When replacing parts, only use the original grade screws.**

☞ **The rear underride protection bar is an officially approved system and should not be modified without the approval of the underride protection bar manufacturer's technical department.**

Lights and signalling

Electrical circuitry

- ◆ The electrical circuitry supplies power to all lights, interior and exterior, as well as to all electrical instruments.

Repair and maintenance

- ◆ Only qualified, skilled professionals may carry out work on the system.
- ◆ During repair, the model and exact placement of devices concerned, as well as wire diameters and fuse capacity must be observed. Please refer to your body and carrier documentation for full details on electric circuitry.
- ◆ Only bulbs with identical technical specifications and fitting system may be used to replace faulty ones.
- ◆ Always quote the body serial number when ordering spare parts.

2. CityLight

Simple **CityLight**



Double **CityLight**

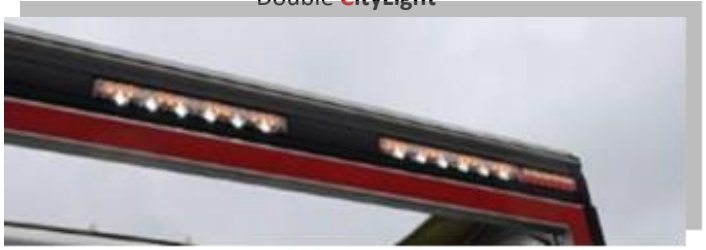

Description

The **CityLight** is mounted at the rear of the vehicle in the upper part, positioned in continuity with the 3-function light.

It is composed of:

- A 3-function light: stop, space requirement
- An approved scrolling indicator light
- A working light

<u>Simple CityLight</u>	<u>Double CityLight</u>
<p>Scrolling direction indicator (approved)</p> <p>Work light (not approved)</p> <p>Stop and end-outline marker lamp (approved)</p>	<p>Flasher: scrolling on both ramps (not approved)</p> <p>Scrolling direction indicator (approved)</p> <p>Work light (not approved)</p> <p>Stop and end-outline marker lamp (approved)</p>

The activation of the work light and the scrolling on both ramps (Double **CityLight**) is done when the tailgate is activated (not allowed in traffic).

T.I.R. Equipment

- ◆ The T.I.R. option is necessary for transportation under the International Road Transport standard.
This equipment allows the sealing of the cargo by customs.
- ◆ The compliance certificate issued for T.I.R. approved vehicles must always be carried in the vehicle.
- ☞ **Upon expiry of this certificate, your vehicle must be submitted to the competent authorities of the country in which the vehicle is registered for new certification.**

Identification

- ◆ Every time transportation is carried out in the T.I.R. regime, rectangular T.I.R. plates must be displayed at the front and rear of the vehicle, in the designated places.
- ◆ T.I.R. plates should only be displayed when transportation is being carried out in T.I.R. mode; in all other cases they should either be removed or crossed through diagonally.

Fitting seals

The following places are provided for customs seals:

- Rear and side door handles,

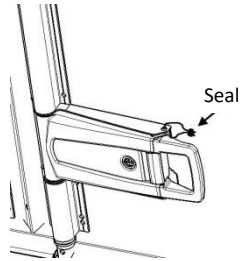

- T.I.R. mounting plates (across the plate, through each eyelet on the mounting nut).

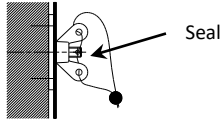

- Mounting tie rods on the refrigeration unit.

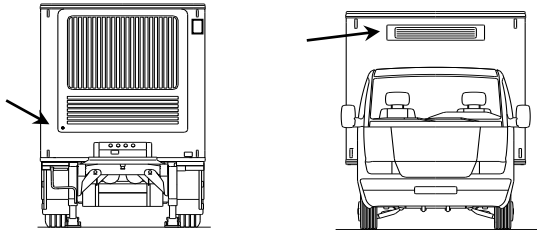

Auxiliary equipment

This chapter provides a non-exhaustive list of auxiliary equipment which may be installed on your vehicle as an option.

1) Tailgate lift

- ◆ The lift is installed at the rear of the body to facilitate the loading and unloading of goods. A technical information booklet and checklist are supplied with the lift and should always be kept in the vehicle.

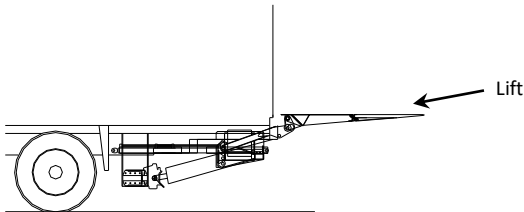

Identification

- ◆ The lift identification plate is situated on the right hand side at the rear of the vehicle.

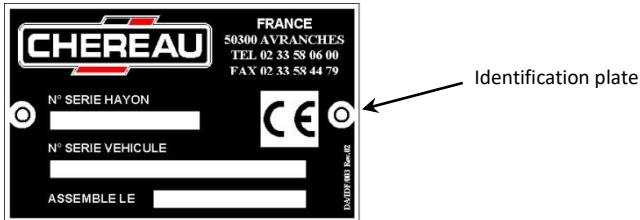

 **The lift serial number must be quoted in all correspondence.**

Operation

- ◆ Before using the lift, please **read the manual carefully**.
- ◆ The control panel is usually placed on the right hand side, at the rear of the body.

Repair and maintenance

- ◆ Only qualified, skilled professionals should carry out work on the lift.

 **Periodical checks described in the operation manual must be carried out as prescribed.**

2) LEVIAND

- ◆ LEVIAND is a piece of equipment, installed at the back of the vehicle, which facilitates the unloading of suspended cargo from inside the vehicle. The instruction and maintenance manual supplied with LEVIAND should always be kept in the vehicle.

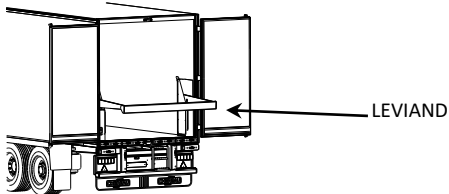

Identification

- ◆ The manufacturer's plate for LEVIAND is situated on the side of the machine's right stand.

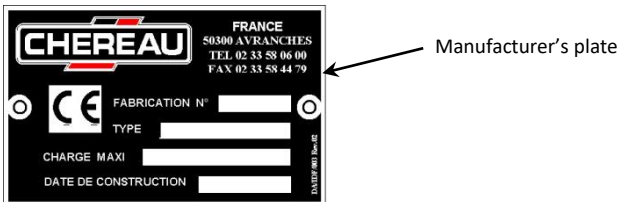

 **The serial number and model of the machine must be quoted in all correspondence.**

Operation

- ◆ Before using the machine please read the manual, particularly the safety guidelines and instructions for use.
- ◆ The control panel is situated inside the body.

Repair and maintenance

- ◆ Only qualified, skilled professionals are permitted to work on LEVIAND.

 **Periodical checks described in the operation manual must be carried out as prescribed.**

3) Pallet holder

- ◆ The pallet holder installed under the body allows unused palettes to be packed away, reducing handling to a minimum.
- ☞ **Pallet holds, regardless of their type, are especially designed to store pallets or in some cases, spare wheels.**

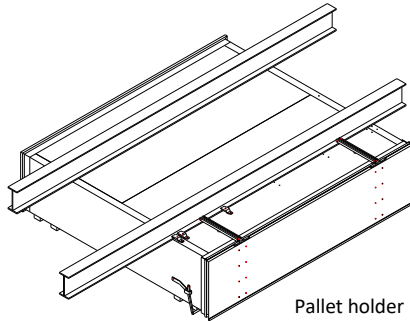

Pallet holder

Operation

- ◆ To open the holder :
 - Where necessary, remove the theft protection.
 - Release the locking mechanism by turning the side handle.
 - Lift the door open.
 - Slide the door above the container.
- ◆ To close, repeat the above operation in reverse order.

4) Wheel holder

- ◆ The wheel holder is situated under the body. It can store one or two spare wheels.

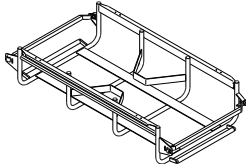
Double basket-type
Wheel holder

- ◆ Depending on the model, access to the wheel holder is either through the back of the vehicle or by the side.

5) Toolbox

- ◆ The toolbox is designed to store tools as well as any other equipment which may be required during transportation.

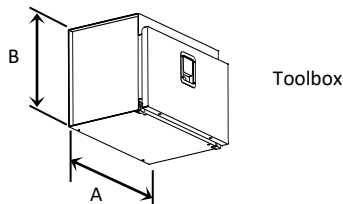

- ◆ To open: pull the door lever to retrieve the toolbox from its casing.

6) Stepladder and ladder

- ◆ The stepladder and the ladder facilitate access to the vehicle. This equipment is fitted with a safety lock and anti-slipping surface on the steps. It is stored either by sliding or by turning under the box.
- ◆ To take the ladder out, unlock and pull out the lodged ladder.
To pack the ladder, push the ladder under the box and ensure that it is locked in place.

7) Fire extinguisher

- ◆ An optional 6kg fire extinguisher is installed on the outside of the body, in a place which is easily accessible by the driver.
This ABC class powder extinguisher is subject to compulsory periodic checks.
- ◆ After each use, even partial, the extinguisher must be refilled.
- ◆ Legal notice: for tractor/semi-trailer combinations, the extinguisher may also be placed on the tractor, outside the cabin, in a place easily accessible by the driver.

8) Central greasing

- ◆ The central greasing system automatically greases all connected equipment such as :
 - Lift joints.
 - Fifth wheel.
 - Axles.The greasing system is powered pneumatically, in parallel with braking.
- The grease level in the greasing system must be checked regularly.
- ◆ When topping up, always use NLGI-0 grease.

9) Rear protection

☞ **The rear protection systems do not remove the necessity for extreme care on the part of the driver when docking.**

- ◆ The rear “CHEREAU bumper” is an optional piece of equipment that effectively protects the rear of the vehicle during docking and loading/unloading. The system is the subject of a registered European patent.

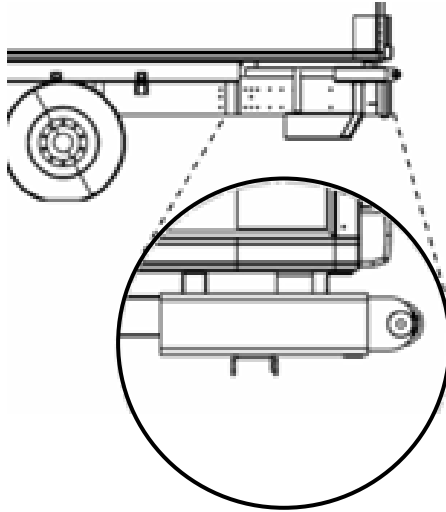

Other vehicles version

- ◆ Rear protection device: as an option, rear protection buffers can be installed on the underride protection bar mountings or on the body loading sill.

ATP Regulations

1) Definition

ATP

- ◆ ATP is an agreement on the international carriage of perishable foodstuffs and on the special equipment to be used for such carriage.
ATP compliance certificates are issued for a limited period of time.

 **Regularly check the expiry date of your ATP compliance certificate.**

Isothermal efficiency

- ◆ Isothermal efficiency is measured using the insulation coefficient "K", calculated on the basis of measurements taken on prototype vehicles in an authorised laboratory.
- ◆ **A vehicle is normally Insulated** if the coefficient K is lower than **0,70 W/m²/°C**.
A vehicle is heavily Insulated if the coefficient K is lower than **0,40 W/m²/°C**.

ATP standards for refrigerated vehicles

- ◆ A refrigerated vehicle is equipped with an isothermal chamber fitted with a refrigeration unit which, at an outside temperature of + 30°C, depending on the standard, is capable of maintaining the interior temperature of an empty chamber at the following temperatures :
 - A Class: the temperature can be set between +12°C and 0°C inclusive.
 - B Class: the temperature can be set between +12°C and -10°C inclusive.
 - C Class: the temperature can be set between +12°C and -20°C inclusive.

2) Marking

- ◆ Example : **FRC**
5-2020 ← Expiry date of the ATP certificate

- ◆ Different markings :
 - Normally-insulated A class vehicle FNA
 - Heavily insulated A class vehicle FRA
 - Heavily insulated B class vehicle FRB
 - Heavily insulated C class vehicle FRC

3) Documents

- ◆ The technical conformity ATP certificate must always be kept in the vehicle.

Noise reduction

Urban deliveries require a reduction in the noise caused by loading and unloading, so as not to disturb local residents. In this respect, vehicles may include special equipment aimed at reducing noise emissions:

- Low noise floor coverings;
- Kick-boards and impact protections made of synthetic material;
- Noise-reduction coatings on tail-lift platforms;
- Automatically opening rear curtains;
- Low noise emission refrigeration unit.

To ensure its effectiveness, all noise reduction equipment must be maintained in good order.

Apart from the equipment itself, noise reduction is based mainly on how it is used and the handling of equipment and accessories. The recommendations below will allow you to reduce noise emissions easily:

1) Handling bulkheads

The inside of body is like an echo chamber. All noise is amplified.

When lifting a bulkhead, hold on to it for as long as possible and release it gently, having allowed a little time for it to slow down

Move the bulkhead gently to limit bearing noise



Hold on to the rising bulkhead and allow it to lock itself into the roof



2) Handling tail-lifts

Deploying the mobile platform on a tail-lift can be one of the main causes of noise nuisance around a vehicle.

A few precautions are necessary when opening and closing it.

Proceed in three steps:

1. Leave at least 10 cm between the platform and the ground.
2. Deploy the platform.
3. Complete the lowering of the platform.



Handle roll stops carefully and regularly check the condition of noise dampers

Hold on to the platform when folding it up and do not let go of it.



3) Handling steps

Ladders and steps will make noise when being opened, if not handled with care.

Pull out ladders and steps gently as far as their stops.



Some ladders reach all the way to the ground. It is recommended that you do not simply allow them to drop to the ground.

Deploy and support ladders and steps at the end of travel and do not let go of them.



Ladders and steps will make noise when being folded away, if not handled with care.

Store ladders and steps by guiding them as far as their stops without banging.



4) Handling doors

When opening a door: If you just let go of a handle, it will bang against its end stop under the effect of the return spring.

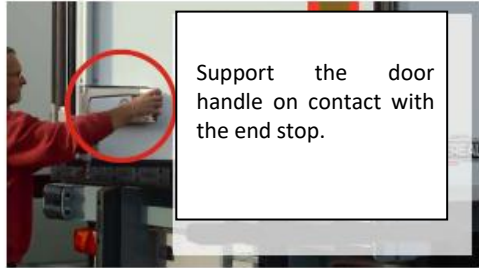

For the same reason and with the same effect, hold the door stay when removing it, to reduce the effect of its return spring.



When closing a door: Position it with the handle open at 90°, taking care not to allow the latch to bang shut.



Servicing

1) General

- ◆ Safety procedures carried out prior to each journey are part of daily maintenance.
- ☞ **To keep your vehicle body in good condition, it is essential to follow the maintenance instructions and comply with service intervals.**
- ☞ **All maintenance operations must be carried out by qualified, authorised personnel.**
- ◆ Maintenance instructions given in the user manuals for various equipment on the body must also be followed.
- ◆ For each maintenance operation, refer to the chapter concerned or the appendices for more information.

2) Body and internal equipment

Maintenance operations	Frequency <i>Whichever is reached first</i>		
	3,000 km Every week	30,000 km Every 3 months	90,000 km Every year
Check the condition of all seals around doors and partitions	●		
Check partitions visually	●		
Option: check the level in the centralised greasing unit	●		
Greasing of opening mechanisms		●	
Greasing of hanging rails		●	
Check that locking devices on hanging rails operate correctly		●	
Check that the fixings on stowage rails are in good condition		●	
Check that partitions are properly greased and operate correctly		●	
Clean inside of the air curtain		●	
Check the tightening torque of all clamps and securing screws on the body			●
Check the tightening torque of securing nuts on hanging rails			●

Maintenance operations	Frequency <i>Whichever is reached first</i>		
	3,000 km Every week	30,000 km Every 3 months	90,000 km Every year
Check the tightening torque of securing screws on door hinges			●
Check the validity dates on air curtain temperature sensors and replace them every three years			●
Check the condition of side doors and that they operate correctly: seals, moving parts, bearings, fixings			●

3) Refrigeration unit

 Follow the servicing schedule in the user manual.

4) Auxiliary equipment and lighting

Follow the servicing schedule in the various user manuals.

Maintenance operations	Frequency <i>Whichever is reached first</i>		
	3,000 km Every week	30,000 km 1 month	90,000 km Every year
Check that lighting equipment operates correctly	Before each journey		
Check the tightening torque of securing nuts on auxiliary equipment		●	
Grease auxiliary equipment		●	

5) MultiDeck-C equipment

Maintenance operations	Frequency <i>Whichever is reached first</i>		
	3,000 km Every week	30,000 km 1 month	90,000 km Every year
Check poles visually and ensure that they work correctly: Check that both beam handling poles are present and that they work correctly	●		
Check poles visually and ensure that they work correctly: Check the tightening of pole, fall-prevention and pole storage screws	●		
Check beams visually and ensure that they work correctly: Check that there is no distortion or sign of impact that could affect their strength	●		
Check rails visually and ensure that they work correctly: Clean dirt from the rail system that could impede or prevent the movement of beams (wood, adhesives, etc.)	●		
Check rails visually and ensure that they work correctly: Check the tightness of connections and that there is no sign of rails coming adrift	●		
Perform a visual and functional check of rear partition stops (beam protection)	●		
Check that rails are not distorted or bent, which could impede the movement or locking of the beams		●	
Check that there are no cracks along the beam profile or signs of impact; replace a beam, if necessary		●	
Check the condition of the guides between the ends and the beam profile (no sticking) If necessary, replace the bearing mechanism on the non-fixed end			●
Check the condition of the beam rollers and replace them if there is any sign of cracking, distortion or excessive wear			●

Maintenance operations	Frequency <i>Whichever is reached first</i>		
	3,000 km Every week	30,000 km 1 month	90,000 km Every year
Check the condition of the beam profiles and replace them if there is any obvious residual deflection greater than 5mm or cracking at any point along the profile			●
Check the condition of the beam ends for signs of damage, cracking or anything else that might adversely affect the beam's strength Replace components, where necessary			●
Replace any rail that could prevent the free movement of beams			●
Check that screws on beams are tight (roller fixing screw on the end: medium thread lock)			●
Replace markings that are unreadable or badly damaged			●

Reminder: do not grease or lubricate the rails or the beams.

6) Aerodynamic accessories

Maintenance operations	Frequency <i>Every month</i>
Visual check of the Aero Top's attachment status	●

APPENDIX: Torque parameters

Body

Mounting flanges: 5.3 daN.m (bolt M10 class 8.8)

Embedded coupling plate / body fixing screw: 7.0 daN.m (M12 class 8.8 screw)

Rear doors

Hinge mounting screws: 2.2 daN (screws M8 class 8.8).

Carrier Sub frame

Standard version:

Mounting with Polyurethane stud: clamping up to a height
36mm stud size

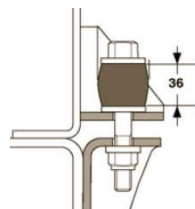

Mounting with steel stud: 17.8daN.m (M14 screw class 10.9)



Sub frame fixing screw (carrier): 17.8daN.m (M14 screw class 10.9)

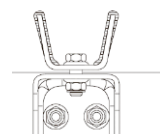

Off Road version (option):

1st flange (left and right): clamping up to a height of 41mm spring

2nd flange (left and right) clamping up to a height of the 39mm spring

3rd flange (left and right) clamping up to a height of the 39mm spring

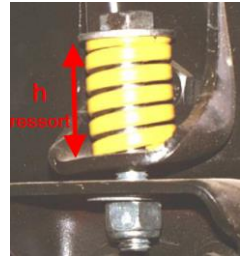

4th Flange and flanges up to the axle (turned over flanges): 6daN.m (screws M14 class 10.9)

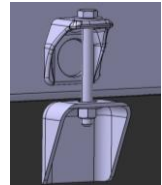

Flanges after axle: 17.8daN.m (M14 screw class 10.9)

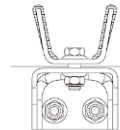
***Internal equipment mounting flanges*****Hanging section:**

Guide rail retaining bolts: 2.7 daN.m

Bulkheads:

Joint retaining bolts: 2.7 daN.m

Palette and wheel holders:

Mounting flanges: 5.3 daN.m

MultiDeck-C:

Beam screws: CB HC A2-70 M8X60 FT ISO 7380 => 20 N.m

Fall arrest screw and beam inlet/outlet: FXi Screw A2-70 M6x20 FT=> 8 N.m



INNOVATION DRIVES YOU FORWARD

We aim to provide you with instructions that best suit your needs.
In this respect, we welcome any comments or suggestions you may have which
might help us improve the quality of this document.

JEAN CHEREAU SAS

ZI le Domaine – 50220 DUCEY-LES-CHERIS

FRANCE

Tél: + 33 (0) 233 580 600

E-mail: contact@chereau.com